

**FACTS ON ALTERNATIVES  
BENEFITS OF RENEWABLES  
VERSUS NUCLEAR**



**ARGUMENTARIUM**

## **Imprint**

---

### **Author**

*Austrian Institute of Ecology*

Mag<sup>a</sup>. Gabriele Mraz, MA

### **Supported by**

Wiener Umweltschutz / Vienna Ombuds Office for Environmental Protection (WUA)

### **Download**

[www.wua-wien.at](http://www.wua-wien.at)

[http://www.ecology.at/wua\\_argumentarium.htm](http://www.ecology.at/wua_argumentarium.htm)

**Vienna, Nov 2019**

## **Foreword**

Inspired by the findings and conclusion from a number of public hearings in the course of the Environmental Impact Assessments processes for nuclear installations, the Vienna Ombuds Office for Environmental Protection (WUA) has asked the Austrian Institute of Ecology to compile this Argumentarium. During these hearings some typical statements have been identified, which can be called outdated or misleading, but are frequently used in the public debate on nuclear energy as well. As a consequence, the well cooperating partners WUA and Austrian Institute of Ecology have decided to perform a fact check for the most common of these statements, compile and explain updates in knowledge and by these means facilitate and enhance a fact-based debate.

We are happy to provide well founded facts and a framework to adjust statements like “nuclear energy provides a vast number of jobs” and “the energy payback time for photovoltaic is longer than its lifetime”. We hope that this Argumentarium will be a helpful and interesting tool in the discussion on the advantages and disadvantages of nuclear energy and will supply updated information on renewables.

Andrea Schnattinger

David Reinberger

Vienna Ombuds Office for Environmental Protection (WUA)

## **Content**

<b>1</b>	<b>INTRODUCTION .....</b>	<b>5</b>
<b>2</b>	<b>EFFECTS ON EMPLOYMENT .....</b>	<b>6</b>
<b>3</b>	<b>FATALITY RISK OF ENERGY TECHNOLOGIES.....</b>	<b>11</b>
<b>4</b>	<b>MINERALS AND METALS FOR FUEL AND CONSTRUCTION .....</b>	<b>13</b>
<b>5</b>	<b>GREENHOUSE GASES AND OTHER EMISSIONS.....</b>	<b>17</b>
<b>6</b>	<b>COSTS .....</b>	<b>20</b>
<b>7</b>	<b>NATIONAL SUPPORT SCHEMES.....</b>	<b>25</b>
<b>8</b>	<b>ENERGY SUPPLY SECURITY .....</b>	<b>31</b>
<b>9</b>	<b>ANNEX: INFORMATION ON INSTALLED CAPACITIES OF RENEWABLE ENERGIES AND PRODUCED ELECTRICITY .....</b>	<b>34</b>
<b>10</b>	<b>REFERENCES.....</b>	<b>39</b>
<b>11</b>	<b>ABBREVIATIONS.....</b>	<b>41</b>

# 1 Introduction

When the project of a new nuclear power plant (NPP) is started, the public has the right to participate in the (transboundary) Environmental Impact Assessment procedure (EIA), which is required for an environmental license. In last years' procedures in Central or Eastern Europe, more and more arguments concerning the energy production were used by the operators and authorities of the envisaged NPP which need to be verified: It is claimed that – in comparison to renewable energies – NPPs create more jobs, that nuclear energy is essential for supply security, that it has lower fatality risk and that it reduces dependence on raw materials and has neglectable emissions.

For the siting communities and the interested public it is often not easy to argue against the alleged benefits of nuclear energy due to counter-arguments not being on the spot in necessary detail.

Therefore, the Vienna Ombuds Office for Environmental Protection (Wiener Umweltanwaltschaft) has supported this Argumentarium with the aim to collect helpful arguments focusing on renewable energies and their positive effects compared to nuclear energy.

This Argumentarium processes new scientific work and policy papers to inform about facts and figures that clarify open questions in the debate of renewables versus nuclear.

Nowadays, different types of renewables are used in the European Union and globally. Not all technologies are discussed in this Argumentarium, the focus is on photovoltaic and wind because they are mainly questioned as too expensive, too dangerous and too material intensive and causing too much grid instability.

Each chapter starts with a few typical arguments from actual debates in public hearings. After presenting some facts and most current data, a conclusion is drawn on these arguments.

## 2 Effects on employment

Arguments from EIA procedures:

- If the NPP would not be built, the regions would face an enormous decrease in economy.
- Thousands of jobs would be lost, the unemployment rate would increase significantly
- Due to the NPP employer the region stays self-sufficient and autonomous.

Employment in the energy sector includes a wide range of jobs, starting from mining of raw materials, production of fuel, research on and manufacturing of technology, installation, licensing, operation and maintenance, marketing, decommissioning, management of waste etc. These jobs are not only created in the country hosting the power plant or photovoltaic panels or hydro dam, but all over the world.

Job creation in the energy sector on a global level cannot be one-to-one allocated on the regional level. For a region it is important that local and regional jobs are available to keep (young) people from relocating to other parts of the country with better economic chances.

### The global perspective

Trends for total employment by energy production are depending on policy decisions on climate protection. In a new study, researchers have compared the number of jobs for different climate protection scenarios. (Teske et al. 2019) Included in the assessment of total jobs were construction, manufacturing, operations and maintenance and fuel supply. The 5°C scenario is based on the International Energy Agency' World Energy Outlook, the 1.5°C scenario on Greenpeace's assumptions of technically possible measures.

**Table 1: Global total employment (thousand jobs) in a 5.0°C and 1.5°C scenario**  
(Teske et al. 2019, p. 23)

Technology	2015	5.0C				1.5C			
		2020	2025	2030	2050	2020	2025	2030	2050
Coal	10,070	8,460	8,380	7,254	4,652	4,788	2,568	1,080	69
Gas, oil & diesel	2,571	3,503	3,820	4,112	4,812	3,686	3,934	4,366	1,643
Nuclear	661	706	667	647	555	406	312	221	13
<b>Renewable</b>	<b>16,663</b>	<b>16,481</b>	<b>16,739</b>	<b>18,310</b>	<b>19,503</b>	<b>27,502</b>	<b>41,334</b>	<b>48,116</b>	<b>46,105</b>
<i>Biomass</i>	11,196	11,058	11,106	11,334	11,652	11,827	12,882	12,777	11,321
<i>Hydro</i>	1,702	1,623	1,925	2,586	3,191	1,421	1,027	1,966	1,892
<i>Wind</i>	970	986	971	1,396	1,702	3,851	6,469	7,705	9,764
<i>PV</i>	1,964	2,314	2,229	2,259	1,865	8,767	13,616	15,142	14,225
<i>Geothermal power</i>	27.5	25.5	33.2	35.2	33.5	94.7	285	348	459
<i>Solar thermal power</i>	23.0	34.4	47.0	106	185	160	1,057	2,334	5,452
<i>Ocean</i>	2.5	3.0	4.1	9.7	21.6	123	279	427	620.8
<i>Solar – heat</i>	710	389	383	549	816	212	1,025	1,390	1,207
<i>Geothermal &amp; heat pump</i>	67.7	47.2	40.6	34.9	37.3	1,047	4,695	6,027	1,166
<b>Total jobs (thousands)</b>	<b>29,964</b>	<b>29,150</b>	<b>29,606</b>	<b>30,323</b>	<b>29,522</b>	<b>36,383</b>	<b>48,149</b>	<b>53,783</b>	<b>47,831</b>

On a global level the number of jobs in renewable energy is increasing in both scenarios, and in both future assessments more than compensating job losses in fossil and nuclear energy.

When comparing jobs per MW and differentiating between local jobs (mostly operations and maintenance) and other jobs that are not necessarily local, solar technologies, small hydro and biomass create more jobs than nuclear.

**Table 2: Job years and jobs per MW in 2012 (Dominish et al. 2019a)**

	Construction/installation	Manufacturing	Operation & maintenance	Fuel – primary energy demand
	Job years/MW	Job years/MW	Jobs/MW	
Coal	11.4	5.1	0.14	Regional
Gas	1.8	2.9	0.14	Regional
Nuclear	11.8	1.3	0.6	0.001 jobs per GWh final energy demand
Biomass	14.0	2.9	1.5	29.9 jobs/PJ
Hydro – large	7.5	3.9	0.2	
Hydro – small	15.8	11.1	4.9	
Wind onshore	3.0	3.4	0.3	
Wind offshore	6.5	13.6	0.15	
PV	13.0	6.7	0.7	
Geothermal	6.8	3.9	0.4	
Solar thermal	8.9	4.0	0.7	
Ocean	10.3	10.3	0.6	
Geothermal – heat	6.9 jobs/MW (construction and manufacturing)			
Solar – heat	8.4 jobs/MW (construction and manufacturing)			
Nuclear decommissioning	0.95 jobs per MW decommissioned			
Combined heat and power	CHP technologies use the factor for the technology, i.e. coal, gas, biomass, geothermal, etc., increased by a factor of 1.5 for O&M only.			

### The EU Member States perspective

A new study calculated job perspectives for Europe based on scenarios until 2050. (Ram et al. 2018) As a key result the study concludes that a 100% renewable energy system in Europe – which is technical feasible –will support millions of local jobs in the power sector:

- In 2015, the European power sector employed approximately 2 million people, with approximately half in the fossil fuel sector.
- A 100% renewable power system would employ 3 to 3.5 million people and solar PV emerges as the major job creating industry, employing about 1.7 million in 2050.
- The approximate 800,000 jobs in the European coal industry of 2015 will be decreased to zero by 2050 and will be overcompensated by more than 1.5 million new jobs in the renewable energy sector.

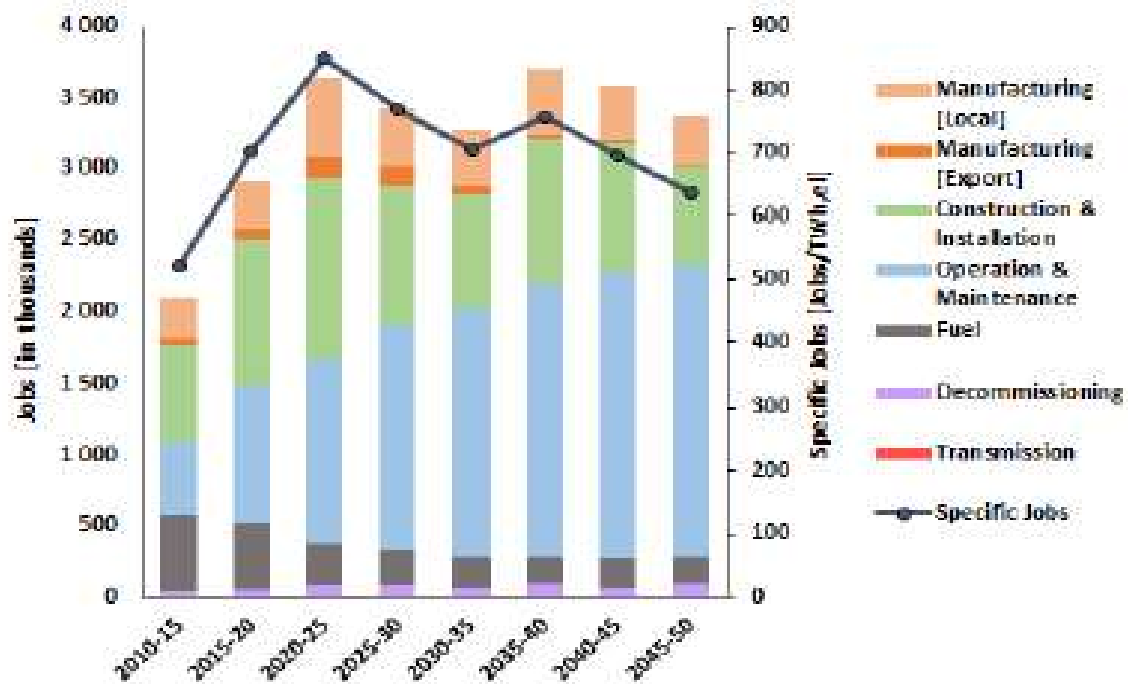

Figure 1: Different categories of jobs created in a scenario of up to 100% renewables up to 2050 (Ram et al. 2018, p. 20)

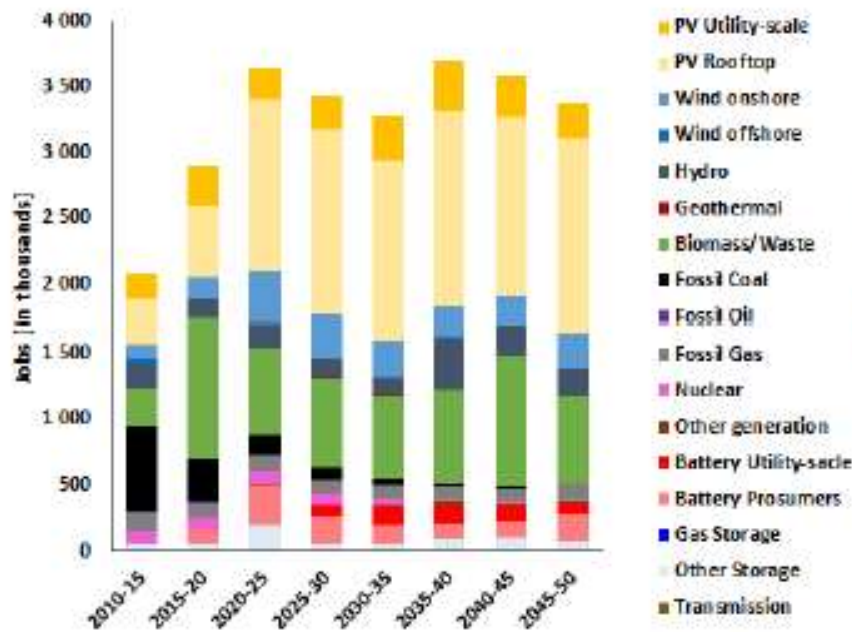

Figure 2: Jobs created by various power generation and storage technologies, scenario up to 2050 in Europe (Ram et al. 2018, p. 20)



### **Example: Study on Dukovany/CZ**

Now, what exactly is a “local job”? On behalf of the employees this would be a job people do not have to relocate for, a job in direct vicinity of their living location. Local job also means job in the country, e.g. in supplying enterprises, manufacturing, constructing and installing technologies, producing fuel and decommission facilities.

A study from the Charles University in Prague and the Czech Academy of Sciences in Brno (Frantál et al. 2016) examined socioeconomic impacts of the Dukovany NPP on the surrounding municipalities in the emergency planning zones (up to 20 km from the NPP) and in the wider area. In 2011, 580 people from the 20 km zone of emergency planning around the NPP worked in the plant corresponding to 1.6% of the economically active population of this zone.

While the authors concluded that the NPP had significant positive impacts on the surrounding communities, they also found that only people in communities in the very vicinity of the NPP (up to 15 kilometres) perceived the socioeconomic impacts of the NPP as significantly positive. Positive effects were also more likely to be reported by people with higher education and of younger age, and by people whose work was connected to the NPP.

The positive socioeconomic effects not only arise from job offers but also from the “Agreement on good neighbourhood”, under which the operator gives donation to the municipalities in the emergency planning zone. The municipalities also get several hundred thousand Euros property taxes from the operator per year. A significant statistical correlation was found between positive perception of socioeconomic effects of the NPP and distance from the plant, but also with the sum of the donations of the operator. On the other hand, no significant correlation was found to the unemployment rate. In the conclusions of the study, the question is asked if these benefits will be reversed after the closure of the plant.

This study shows that local socioeconomic effects cannot only be measured in numbers of jobs, which is very low, or unemployment rates, also the financial dependency from operators has to be analysed which is likely to be stopped after the end of the plant’s lifetime.

**A sustainable long-term local and regional development should not be based on donations from industries/technologies with an expiry date and an uncertain future.**

### **For comparison: Example of job creation by energy efficiency**

A new study of the University of Cambridge focusses on the business case for energy transition of Eastern and Central European countries. (CISL 2019) The study shows big potentials for energy efficiency measures in these countries, amongst others: In Poland, 70% of single family buildings use coal for heating. Also in Poland, 32% of energy for non-residential buildings are used for lightning.

In total, buildings are responsible for approximately 40% of final energy consumption and 36% of CO<sub>2</sub>-emissions in the EU<sup>1</sup>. Thermal insulation and other energy efficiency measures for buildings contribute essentially to climate protection. A co-benefit lies in the mainly local jobs that are created and assured on the long-term by these measures.

The CISL-study shows an example for a business case in Hungary: About 25% of Hungarian households are planning energy efficiency refurbishments within the next five years with a market potential of more than 4 billion Euro.

---

<sup>1</sup> (cited after The Energy Performance of Buildings Directive. (no date). Retrieved from: [https://ec.europa.eu/energy/sites/ener/files/documents/buildings\\_performance\\_factsheet.pdf](https://ec.europa.eu/energy/sites/ener/files/documents/buildings_performance_factsheet.pdf))

In Germany, a study assessed for 2011 the creation of 278,360 fulltime jobs by thermal insulation of buildings. (Weiß et al. 2014) This assessment was based on analysing the refurbishment works on reference buildings. Based on this assessment the study also developed a scenario for Germany until 2030. The scenario first showed a sharp increase in job effects followed by a slight decrease, nevertheless resulting in nearly 300,000 jobs in 2030.

For comparison: For Germany in 2016, 334,000 thousand jobs were created by use of renewable energies (Energieatlas 2018), while the German nuclear industry created in its peak about 30,000 jobs (Gabriel 2016).

### **Conclusions**

On a global level, a new study shows that the number of jobs in renewable energy is increasing in different kind of scenarios (1.5 and 5° scenario), more than compensating job losses in fossil and nuclear energy. When comparing jobs per MW and differentiating between local jobs (mostly operations and maintenance) and other jobs that are not necessarily local, solar technologies, small hydro and biomass create more jobs than nuclear.

That new jobs by renewables can compensate for job losses in traditional energies was also the result for a 100% renewable scenario for the EU.

A study for Dukovany/CZ shows that socioeconomic effects cannot only be measured in numbers of jobs or unemployment rates, also the financial dependency from operators has to be analysed which is likely to be stopped after the end of the plant's lifetime.

### 3 Fatality risk of energy technologies

Arguments from EIA procedures:

- In the last 30 years in OECD countries no nuclear accident occurred. But other energy sources led to some death cases.
- There is more risk of accidents and deaths by renewable energies, coal and gas than nuclear.
- You cannot deduce illnesses from radiation dose, neither backwards nor forwards. Death in Fukushima came from the tsunami.

Accidents of energy technologies can result in immediate and/or latent fatalities but also in health effects that have severe impacts on living conditions. The nuclear lobby often argues that nuclear power has the lowest number of fatalities of all energy technologies, especially in the EU. This needs a closer look.

When comparing effects from accidents during energy production, there are some publications of NEA and the Swiss Paul Scherrer Institute comparing fatalities per GW (electric)-year (GWey) in OECD and non-OECD countries, see for example the following table:

**Table 3: Severe accidents (defined as >= 5 fatalities) in fossil, hydro and nuclear energy production chains during 1969-2000. Fatalities for nuclear are immediate fatalities only. NEA-OECD (2010, p. 35)**

Energy Chain	OECD			Non-OECD		
	Accidents	Fatalities	Fatalities/ GWey	Accidents	Fatalities	Fatalities/ GWey
Coal	75	2,259	0.157	1,044	18,017	0.597
Coal (data for China 1994-1999)				819	11,334	6.169
Coal without China				102	4,831	0.597
Oil	165	3,713	0.132	232	16,505	0.897
Natural Gas	90	1,043	0.085	45	1,000	0.111
Liquefied petroleum	59	1,905	1.957	46	2,016	14,896
Hydro	1	14	0.003	10	29,924	10.285
Nuclear	0	0	-	1	31	0.048
<b>Total</b>	<b>390</b>	<b>8,934</b>		<b>1,480</b>	<b>72,324</b>	

Hydro: Banqiao and Shimantan dam failures alone caused 26,000 fatalities.

This table would confirm the low fatality rate of nuclear energy.

But: Severe nuclear energy accidents do not mainly result in immediate fatalities, but in significant long-term health consequences, amongst them latent fatalities. The picture becomes more realistic when these latent health effects are also included as the following figure from the Intergovernmental panel on Climate Change (IPCC) shows.

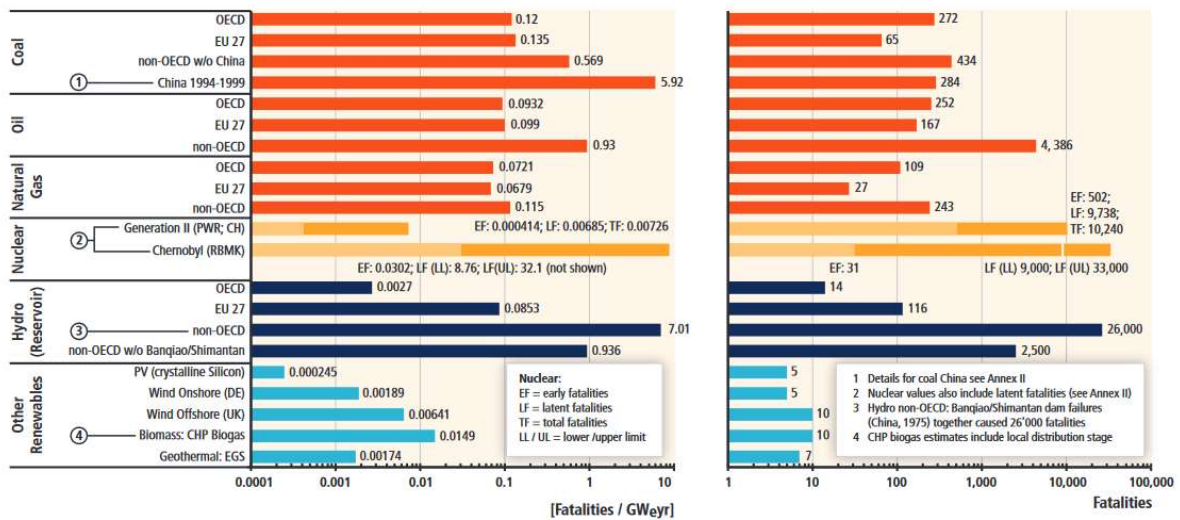

Figure 3: Comparison of fatality rates and maximum consequences of operating large energy technologies, including accidents in the fuel chain; the accident of Fukushima is not included. (IPCC 2012, p. 746)

The fatality per GWey (sum of immediately and latently) in OECD countries are lowest for PV, wind and geothermal, followed by hydro and after that nuclear.

When compared to the accident in Chernobyl, nearly all other energy technologies have lower fatality rates (except big dam breaks and some large accidents in coal production). Furthermore, it has to be recognized that a big dam break may cause a large number of immediate fatalities but does not necessarily have long-term (genetic) impact on a number of future generations like a severe nuclear accident.

The risk of a severe nuclear accident like Chernobyl or Fukushima has been recently recalculated. Swiss, Danish and UK researchers made an analysis of 216 nuclear energy accidents and incidents. (Wheatley et al. 2016) For their definition of extreme risk they included accidents that had at least 20 million USD in damages. The authors assess a 50% chance that such a severe accident occurs every 60-150 years, that is once or even twice in a century. Smaller accidents like Three Mile Island/USA could even happen every 10-20 years according to this statistical assessment.

### Conclusions:

To compare fatalities resulting from severe accidents in energy technologies, not only immediate deaths but also latent deaths from the whole fuel chain have to be considered. When doing so, renewable energies have the lowest fatality rate per GWey from severe accidents.

## 4 Minerals and metals for fuel and construction

Arguments from EIA procedures:

- Raw metal need for renewables is higher than for nuclear.
- PV needs ten times more iron, 50 times more copper, 100 times more aluminium than uranium mining

A study of the World Bank (2017) complains about the lack of literature examining the metal footprint of fossil fuel generation technologies and nuclear plants. The literature focuses mainly on the metal intensity of renewable technologies.

Which metals and minerals are needed in which technology?

- A typical crystalline silicone PV panel consists of 76% glass (panel surface), 10% polymer (encapsulant and back-sheet foil), 8% aluminium (frame), 5% silicon (solar cells), 1% copper (interconnectors) and less than 0.1% silver (contact lines) and other metals (tin, lead).
- A CdTe PV panel consists of 96-97% glass, 3-4% polymer, and less than 1% semi-conductor materials (cadmium, tellurium) and other metals (nickel, zinc, tin).
- A CIGS PV panel consists of 88-89% glass, 4% polymer, less than 1% semi-conductor material (indium, gallium, selenium) and other metals (copper).
- Wind turbines (geared): iron ore, copper, aluminium, limestone, carbon, chromium, manganese, nickel, zinc; and about 80% steel for tower, nacelle and drivetrain.
- Wind turbines (with direct-drive magnetics; about 20% of all turbines in use) need the above and additionally lead and rare earth metals neodymium and dysprosium.
- Lithium ion batteries (typical for electric vehicles): graphite, copper, aluminium; types are NMC (nickel, manganese, cobalt), LFP (lithium-iron phosphate), NCA (nickel, cobalt, aluminium) and LMO (lithium-manganese oxide). Most common are NMC and NCA.
- Lead-acid batteries: lead, steel

(Data from Giurcu et al. 2019 and World Bank 2017)

Nuclear energy needs materials for construction of the facilities, for mining and milling of Uranium, for fuel production and for conditioning and disposal of the nuclear waste. The decommissioned facilities lead to metal scrap that is partially radioactive and has to be managed as nuclear waste.

**Table 4: Comparison of metal use of nuclear, PV and wind (World Bank Group 2017; Dominish et al. 2019b; data on nuclear from Moss et al. 2011; Tokimatsu et al. 2018)**

	PV	Wind	Nuclear (newbuild; data mostly from AP1000 or decommissioned PWR)
<b>Metal</b>	<b>Range of estimates in kg/MW</b>		
Aluminium	102-32,000	560	
Boron	0.0008	0.8-7	
Cadmium	0.93-83.51		0.5
Chromium		789-902	427
Copper	17-2,194	1,140-3,000	59.6-2,500
Dysprosium		2.8-25	
Gallium	0.12-6.17		
Hafnium			0.5
Indium	4.5-83.8		1.6
Iron (in magnet)		52-455	
Iron (cast)		20,000-23,900	
Lead	72.4-269.3	Range unknown	4.3
Manganese		32.5-80.5	
Molybdenum	0-unknown	116-136	20-71
Neodymium		0-186	
Nickel	Unknown	557-663	256
Niobium			2
Praseodymium		4-35	
Selenium	0.5-84.4		
Silicon	0-18.4		
Silver	5.17-19.2		8.3
Steel	Unknown	103,000-115,000	Unknown
Terbium		0.8-7	
Tellurium	4.7-90.4		
Tin	5.95-463.1		4.6
Titanium			1.5
Tungsten			5
Vanadium			0.6
Yttrium			0.5
Zinc		5,150-5,750	
Zirconium			30.5

It becomes obvious that nuclear energy also depends on metals and minerals, f.e. copper and silver. The demand is varying according to the technology used.

To assess which metals and minerals can cause problems in future, a study from European Commission's Joint Research Centre can be used (Moss et al. 2013). In this study, criticalities of raw materials are assessed. The following table shows critical metals for a scenario of demand 2020-2030.

**Table 5: Criticality rating of shortlisted raw materials (Moss et al. 2013), REE = rare earth elements**

High	High-Medium	Medium	Medium-Low	Low
REE: Dysprosium, Europium, Terbium, Yttrium	Graphite	REE: Lanthanum, Cerium, Samarium, Gadolinium	Lithium	Nickel
REE: Praseodymium, Neodymium	Rhenium	Cobalt	Molybdenum	Lead
Gallium	Hafnium	Tantalum	Selenium	Gold
Tellurium	Germanium	Niobium	Silver	Cadmium
	Platinum	Vanadium		Copper
	Indium	Tin		
		Chromium		

What can be done to reduce the metal and mineral use and to avoid bottlenecks?

Giurco et al. (2019) conducted a study on metal demand for solar PV, wind and batteries. The authors used an ambitious scenario of 100% renewables in 2050 which would limit climate change to 1.5 degrees. Under the assumption that the main technology type (crystalline silicon PV) will not change until 2050, the authors modelled potentials for increased recycling and increases material efficiency. Especially cobalt, lithium and silver will show increasing demand which will exceed current reserves. Therefore, recycling will be important, also more efficient methods of cobalt use in batteries.

The following figures shows an evaluation of future changes in the composition of solar PV panels, and the potential for recovery of materials.

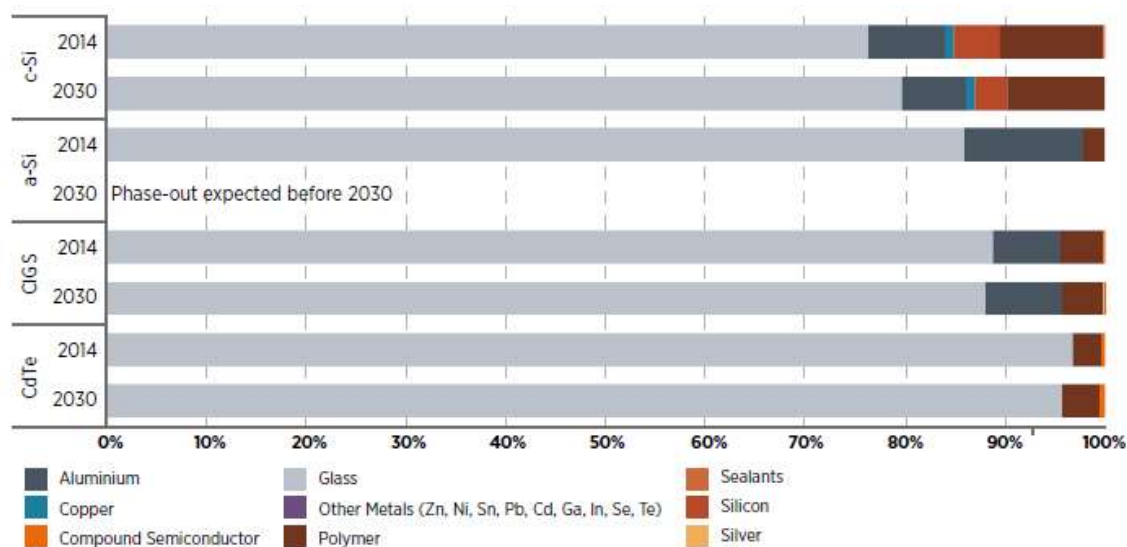

Based on Marini et al., (2014); Pearce (2014); Raithe (2014); Bekkelund (2013); NREL (2011) and Sander et al., (2007)

**Figure 4: Evolution to 2030 of materials used for different PV panel technologies as a percentage of total panel mass (IRENA and IEA-PVPS 2016, p. 41)**

The estimates of recovery in the following figure are based on expected PV cell technology ratios and related waste composition multiplied by the cumulative waste volume of 1.7 million tons for 2030 under the regular-loss scenario.



Figure 5: End-of-life recovery potential under regular-loss scenario to 2030, in tons (IRENA and IEA-PVPS 2016)

### Uranium

The heavy metal uranium is needed for nuclear fuel, and its mining and milling result in heavy pollution of the environment. Waste rock contains radioactive and toxic decay products, radioactive dust particles are spread by wind, the high concentrations of radon increases lung cancer risk, and radioactive contamination of water is a known problem. When using in-situ-leaching, toxic chemicals like cadmium, arsenic and nickel pose a threat to the aquifer. Sludge tailings as byproduct from uranium extraction contain long-lived decay products and chemical substances. Uranium is a limited resource. The date of its depletion can be expected in a few decades, depending on assumptions of demand, type of uranium resource and market conditions. (Wallner 2012)

#### Conclusion:

Yes, renewable energies need minerals and metals and there can be future shortages. But there are other solutions for these shortages being developed: recovery, recycling and substitution.

Nuclear energy needs metals, too, esp. hafnium and indium where shortages could be expected (Moss et al. 2013) Uranium resources will also be depleted in the next decades. Uranium mining and milling has lead and leads to enormous amounts of radioactive and toxic wastes that increase the risk for severe health effects and are dangerous for people and environment.



## 5 Greenhouse gases and other emissions

Arguments from EIA procedures:

- Nuclear power is CO<sub>2</sub>-free.
- Nuclear power is low carbon.
- You have to conclude that the emission question from fossil fuels you are using is not solved, either, and nobody knows its impacts on environment.

In 2011, the IPCC gave a comprehensive estimate of life cycle greenhouse gas emission. In the following figure the number of references and estimates (more than one per reference depending on the use of different scenarios) is shown, and as a result the median and statistical information on minimum and maximum.

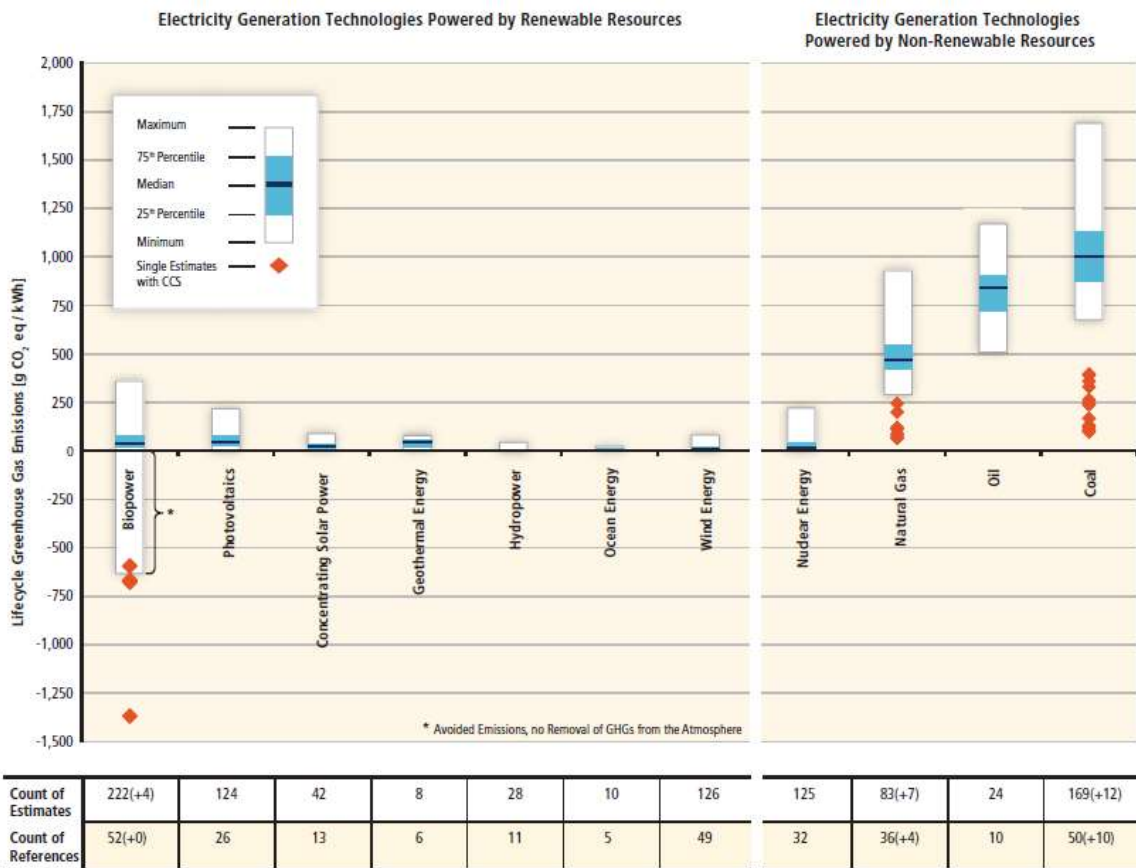

**Figure SPM.8 |** Estimates of lifecycle GHG emissions (g CO<sub>2</sub>eq/kWh) for broad categories of electricity generation technologies, plus some technologies integrated with CCS. Land use-related net changes in carbon stocks (mainly applicable to biopower and hydropower from reservoirs) and land management impacts are excluded; negative estimates<sup>10</sup> for biopower are based on assumptions about avoided emissions from residues and wastes in landfill disposals and co-products. References and methods for the review are reported in Annex II. The number of estimates is greater than the number of references because many studies considered multiple scenarios. Numbers reported in parentheses pertain to additional references and estimates that evaluated technologies with CCS. Distributional information relates to estimates currently available in LCA literature, not necessarily to underlying theoretical or practical extrema, or the true central tendency when considering all deployment conditions. [Figure 9.8, 9.3.4.1]

**Figure 6: Estimates of lifecycle greenhouse gas emission in CO<sub>2</sub>eq/kWh (IPCC 2011, p. 19)**

This IPCC figure shows that nuclear energy has a low median, but a maximum of about 230 g CO<sub>2</sub>eq/kWh. Renewable energies have lower maxima, the median is about the same magnitude as nuclear.

Calculations from the German Ökoinstitut using the ecoinvent database result in the following average CO<sub>2</sub> emissions:

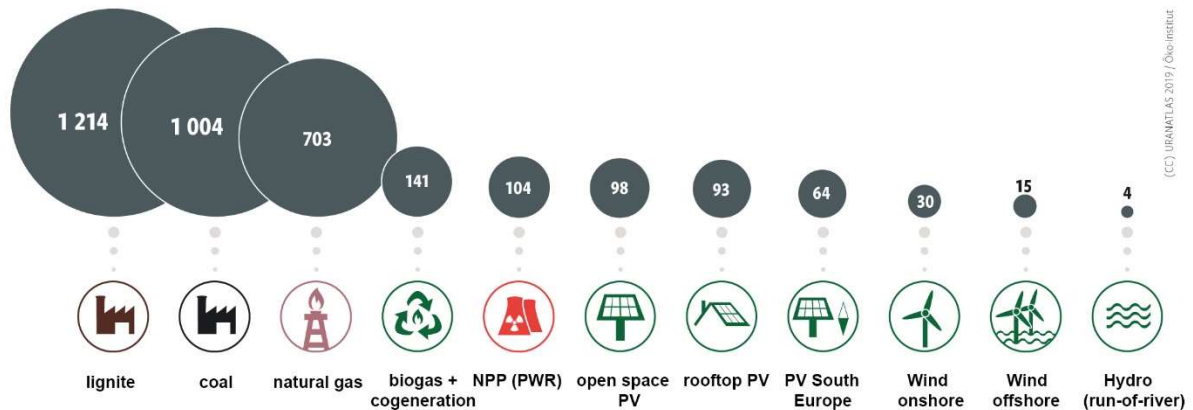
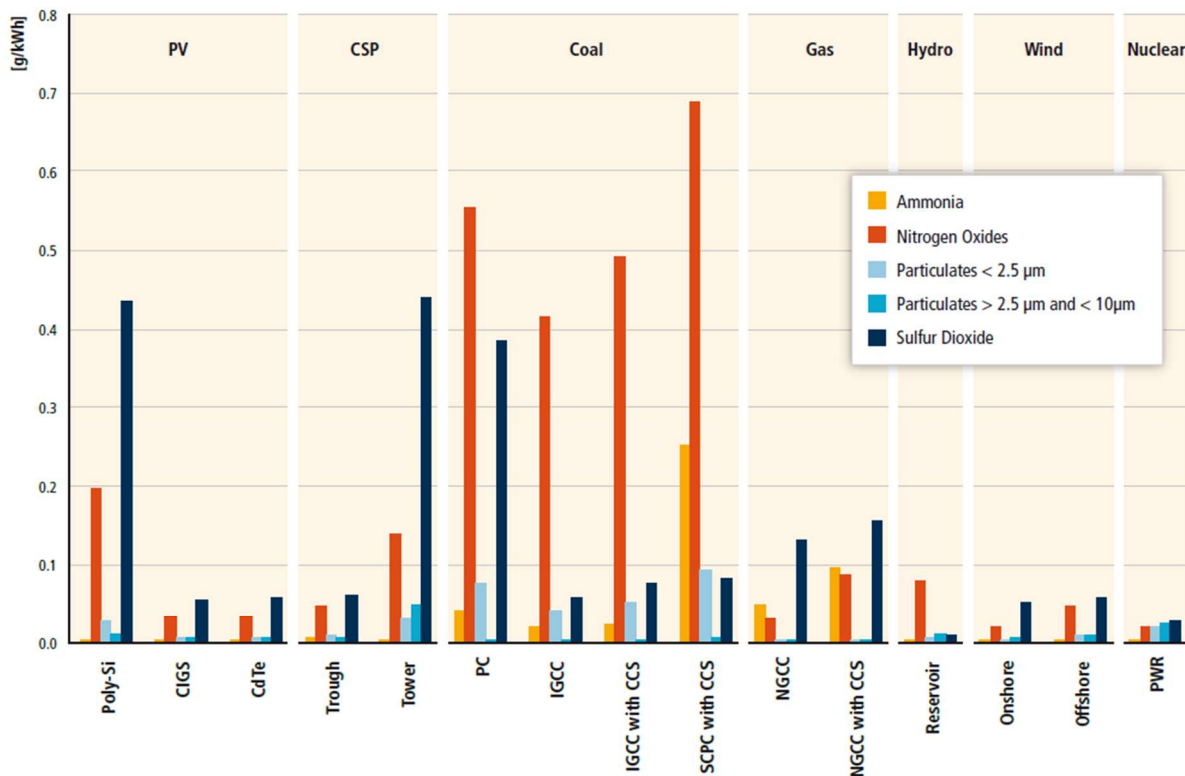

Figure 7: CO<sub>2</sub> emissions from various energy production systems, in g CO<sub>2</sub> per kWh. (Uranatlas 2019)

In this calculation, the emissions from renewable energies are in average lower than for nuclear.

A study that is very often quoted when looking at CO<sub>2</sub> emissions from nuclear power is Sovacool (2008). Sovacool compared 103 lifecycle studies of greenhouse gas-equivalent emissions for NPPs. The range he found was 1.4 to 288 g CO<sub>2</sub>eq/kWh, with an average of 66g. He explains that nuclear power is not directly emitting CO<sub>2</sub> but emits it via its life cycle, including the construction of the plant, uranium mining and milling and decommissioning. The contribution of nuclear power to climate protection is relativized when taking into account the declining uranium ore grades: Nuclear power can be referred to as “low-carbon” when the ore grade is high (0.1 bis 2%). However, ore grades of around 0.01 % make the CO<sub>2</sub> emissions increase up to 210 g CO<sub>2</sub>/kWh, and ore grades below 0.01 % can result in over 500 g CO<sub>2</sub>/kWh. (Wallner et al. 2011)

The IPCC assessed also **other emissions than CO<sub>2</sub>**. The following figure shows the results.



**Figure 7.8 |** Life-cycle inventory results of the production of 1 kWh of electricity for important air pollutants contributing to particulate matter (PM) exposure, the leading cause of health impact from air pollution. The technology modelling considers state-of-the-art pollution control equipment for fossil power plants. Data sources: Arvesen and Hertwich (2011); Burkhardt et al. (2011); Whitaker (2013); Dones et al. (2005); Singh et al. (2011). Abbreviations: PC = pulverized coal, PV = photovoltaic, CSP = concentrating solar power, Poly-Si = polycrystalline silicon, CIGS = copper indium gallium selenide thin film, CdTe = cadmium telluride thin film, IGCC = integrated gasification combined cycle, CCS = CO<sub>2</sub> capture and storage, SCPC = supercritical pulverized coal, NGCC = natural gas combined cycle, PWR = pressurized water reactor.

**Figure 8: Life-cycle inventory results of the production of 1 kWh of electricity. (various data sources, quoted in IPCC 2014, p. 548)**

Some renewables technologies have higher emissions of some air pollutants (nitrogen oxides and sulfur dioxide) than nuclear, but most stay in the range below 0.1 g/kWh.

To complete the picture, **radioactive emissions** also have to be taken into account, from uranium mining and milling to emissions from normal operation and from incidents and accidents, even though they do not contribute to climate change.

**Conclusions:**

Nuclear energy is definitely not CO<sub>2</sub>-free. Its CO<sub>2</sub> emissions are only slightly higher than those of renewable energies like solar and wind – but only as long as the uranium ore grad is high. As uranium has to be produced from ore with a low grad, which will be the case within this century, CO<sub>2</sub> emissions are going to rise significantly.

No energy technology is free of emissions of CO<sub>2</sub> and other pollutants. The least emission causes energy that is not produced at all but saved. Nuclear energy causes additional problems with its radioactive emissions.

## 6 Costs

Arguments from EIA procedures:

- For nuclear newbuild in Czech Republic, an electricity price of 55-60 Euro/MWh including all costs (also decommissioning) is expected (2018).
- Czech Republic is liable for costs of nuclear accident up to 312 million Euro (8 billion CKR)
- Decommissions will not result in costs for the state because the operator has to pay for it. In CZ, the operator is obliged to keep a reserve of 391-586 million Euro (10-15 billion CKR) per reactor.
- We do not have a problem with nuclear waste – see natural reactor in Gabun: nuclides do not migrate from the reaction.

### **Nuclear power can no longer be promoted as cheaper than renewable energies.**

2014: The UK Nuclear Industry Association (NIA) said that the strike price for the planned NPP Hinkley Point C/UK of 113.8 Euro/MWh (based on 2012 prices) should be compared with the offshore wind farm price of 190.7 Euro/MWh and 147.6 Euro/MWh for a large solar farm.<sup>2</sup>

2019: In September, auctions for offshore windfarms were held in UK. They resulted in strike prices of 48.8-51.2 Euro/MWh (based on 2012 prices)<sup>3</sup>.

Recent nuclear newbuild projects show that the realized costs are always higher than the planned budgets, and construction times are escalating. A historical analysis of investment costs (Haas et al. 2019) shows that their steady increase. The authors defined major reasons for the cost increases:

- Extra costs arise from additional safety requirements.
- Price increase in raw materials and need for better raw material quality adds to rising costs, also increases in labour costs
- Construction costs have been systematically underestimated.
- Firms do not have the skills to complete projects in time, leading to increase in construction times.
- Changes in generation of reactors and designs reduce possible learning effects.
- Scaling-up has not decreased costs.

---

<sup>2</sup> <https://www.world-nuclear-news.org/NP-Hinkley-Point-C-contract-terms-08101401.html>, seen 22 Sept. 2019

<sup>3</sup> <https://www.offshorewind.biz/2019/09/20/uk-offshore-wind-strike-prices-slide-down-to-gbp-39-65-mwh/>, seen 22 Sept 2019

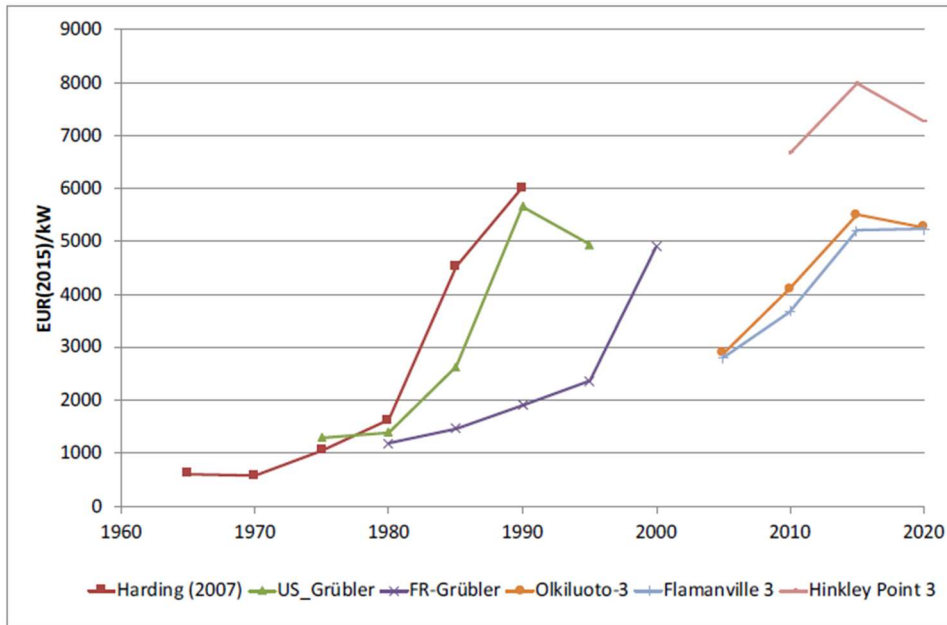

Figure 9: A comparison of studies on the historical development of investment costs of NPPs (Haas et al. 2019)

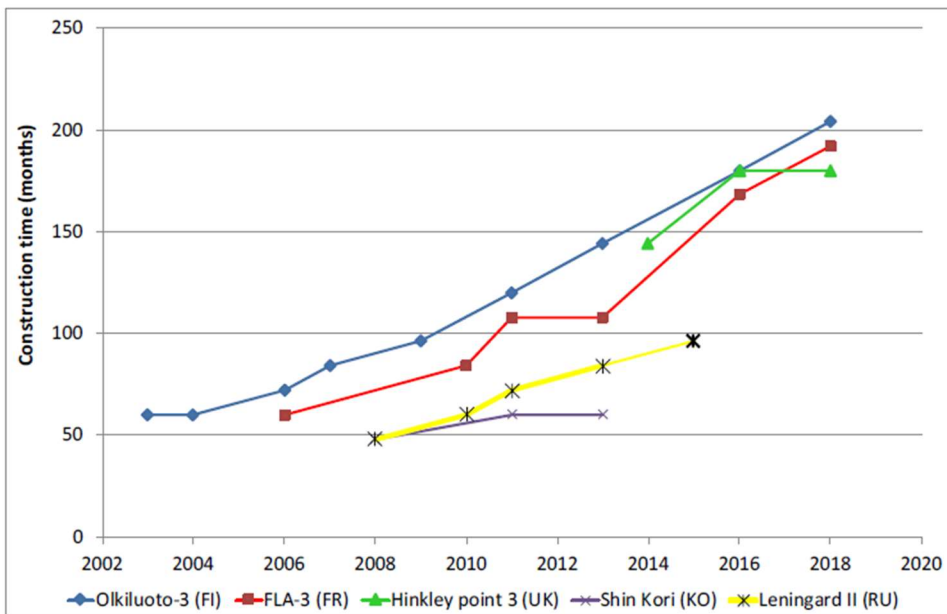
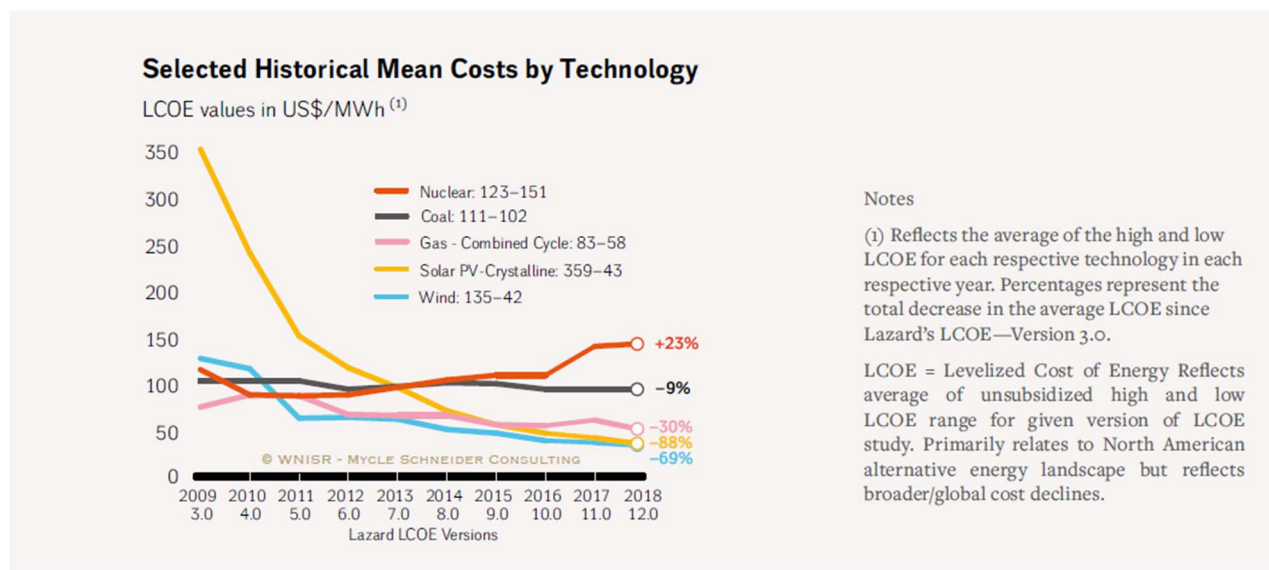

Figure 10: Increase in construction times on nuclear new build projects (Haas et al. 2019)

On the other hand, costs for solar and wind are decreasing sharply.

The 2019 World Nuclear Industry Status Report shows that levelized costs of energy (LCOE) on a global level are rising for nuclear while falling for renewable energies:



Source: Lazard Estimates, 2018<sup>936</sup>

Figure 11: The declining cost of renewables versus traditional power sources (WNISR 2019, fig 40, based on Lazard 2018) (1 USD/MWh in 2018 equals 0.85 Euro/MWh)

While the underlying data from the above figure focus primarily on the USA, data from IRENA in table 6 provide a similar picture for renewables globally – costs are decreasing enormously.

Table 6: Global electricity costs in 2018, change in cost 2017-2018 (IRENA 2019) (1 USD/kWh in 2018 equals 0.85 Euro/kWh)

	Global weighted average cost of electricity (in USD/kWh) 2018	Cost of electricity: 5 <sup>th</sup> and 9 <sup>th</sup> percentiles (in USD/kWh) 2018	Change in the cost of electricity 2017-2018
Bioenergy	0.062	0.048-0.243	-14%
Geothermal	0.072	0.060-0.143	-1%
Hydro	0.047	0.030-0.136	-11%
Solar photovoltaics	0.085	0.058-0.219	-13%
Concentrating solar power	0.185	0.109-0.272	-26%
Offshore wind	0.127	0.102-0.198	-1%
Onshore wind	0.056	0.044-0.100	-13%

**Energy payback time:** The energy payback time is the length of time required for photovoltaic solar modules to generate an amount of energy equal to the energy used for manufacturing them. The Fraunhofer Institute has analyzed payback times of PV in Europe. (Fraunhofer ISE 2018). The figure shows that the energy payback time is depending on the geographical location – less sunlight results in higher payback time. In southern Europe, energy payback times are about 1 year. If a lifespan of 20 years of the PV is assumed, this PV system will produce twenty times the energy that was used for producing.

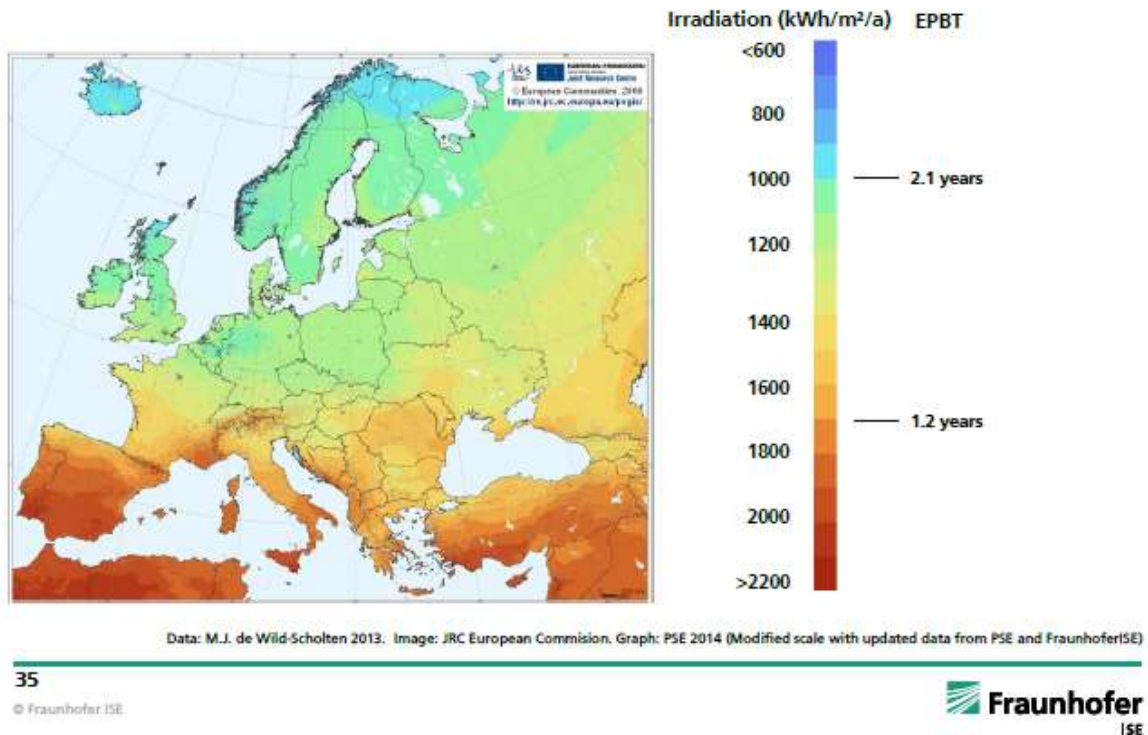

Figure 12: Fraunhofer ISE (2018): Energy payback times of multicrystalline silicon PV rooftop systems – geographical comparison

### Costs for decommissioning and waste management

The prediction of the costs for decommissioning have a high uncertainty as not many reactors have been fully decommissioned by now. In Lithuania, decommissioning cost estimates for two reactors have increased by two-thirds in five years to Euro 3.1 bn (USD 3.7 bn), and if waste management was included, even to Euro 5.8 bn (USD 6.8 bn), leaving a funding gap of Euro 4 bn (USD 4.7 bn). In Italy, decommissioning costs for four reactors have doubled since 2004 to Euro 6.9 bn (USD 8.1 bn). (WNISR 2019)

It remains to be seen what the real costs for decommissioning of different European reactors will be, and if the funds will be able to cover the total sums.

Directive 2011/70/Euratom obliges the EU Member States to give information on their nuclear waste management programs including the envisaged costs and financing of these costs. In 2017, the European Commission (EC) evaluated the submitted national programs, one of EC’s conclusions is: “Some Member States need to demonstrate ownership of the cost assessments of their national programs, as they appear currently to rely mostly on the spent fuel and radioactive waste generators’ cost assessments.” (EC Report, p. 15)

And a recent example from Bulgaria shows that the situation has not improved: The latest ARTEMIS mission in Bulgaria resulted in the following recommendation no. 4: “The Government should ensure that financial provisions for geological disposal are made.” This recommendation was made because the peer review team was informed that the cost for geological disposal was not included in the activities covered by the radioactive waste fund. (Mraz and Lorenz 2019)

This confirmed what is widely been known by independent experts and suspected by the public: many member states do not have reliable data about the future costs of their nuclear programs' back-end and certainly do not have the financial means to cover them. The key question is who will pay for the external costs of nuclear waste management once the dedicated funds have run dry, in particular once the waste generators after decommissioning of the last NPPs will have stopped their contributions into those funds. There will hardly be another solution but making the taxpayers pay.

### **Costs of liability for severe nuclear accident**

The costs for energy production not only include construction, financing, operation & maintenance; decommissioning and waste management, but also costs for negative impacts on humans and the environment – so-called external costs because they are not included in the energy costs, they are externalized and have to be paid by taxpayers.

Severe accidents like Chernobyl or Fukushima are costing huge amounts in damage – different sources estimate costs of 64-5,244 bn Euro (Wallner and Mraz 2013). The costs of future severe accidents could also be very high – the French IRSN calculated costs of 155-855 bn Euro (IRSN 2012). NPP operators and states must be insured against such accidents. Since the 1960s, these liabilities have been regulated by several international conventions. Not every nuclear state is member of such a convention: important nuclear states including the USA, Canada, China, India and Japan have not signed any of these agreements. Moreover, where the insurance coverage is inadequate, the shortage also will have to be made up. Calculations show that, as of today, only a few percent of possible accident costs are covered. An insurance forum conducted a comprehensive study into the issue of a sufficient financial coverage of nuclear accidents. (Günther et al. 2011) The authors concluded that even if nuclear industry would be granted the period of 100 years to accumulate the funds needed in case of a possible nuclear accident, consumers would have to pay extra electricity costs of 0.139 – 2.36 Euro/kWh. Electricity prices for consumers in 2018 were in average in countries planning to build new NPPs: 0.159 Euro/kWh Czech Republic, 0.14 Euro/kWh in Poland, 0.11 Euro/kWh in Hungary, 0.10 Euro/kWh in Bulgaria, compared to 0.21 Euro/kWh in EU 28. (Eurostat 2019)

### **Conclusions:**

Nuclear power can no longer be promoted as cheaper than renewable energies. Long construction times and increased investment costs result in the need of state aid to finance the enormous costs of new build.

Moreover, if all external costs and liability costs would be included in electricity costs, they would rise further sharply.

On the other hand, costs for renewables have been decreasing quickly in the last years. Comparisons of LCOE show that on a global level renewables are already cheaper than nuclear.



## 7 National support schemes

Arguments from EIA procedures:

- Renewables can only be realized because they are supported financially.
- Less than 2% of energy is produced by PV in the Czech Republic per year. For this small amount, 1.1 billion Euro (27 billion CKR) have to be supported per year by the taxpayers.
- All renewables in Czech Republic get financial support, about 1,74 billion Euro (45 billion CKR) in 2017.
- The construction of nuclear power is not subsidized, but the renewables are.

State aid and other support mechanisms for energy production are often used as arguments against renewable energy systems – they would not be economic if they were not supported. But nuclear energy and fossil plants get national support, too. There are many different forms of national support, and some of them cannot be seen directly in electricity prices. Nevertheless, taxpayers have to pay for them.

Support mechanisms for renewables changed in the last decades due to the EU's Renewable Energy Directive from 2009. The Council of European Energy Regulators made a survey in 2018 on the new support mechanisms and analyzed data that were provided by the energy regulators of the EU member states with the following results (CEER 2018):

- For the review period of 2016-2017, four types of support schemes were mainly in place in Europe: Feed-in tariffs (FITs); Feed-in premiums (FIPs); Green Certificates (GCs); and Investment grants
- The weighted average support for renewables, on top of the wholesale price, decreased by 12.6% from Euro 110.22/MWh in 2015 to an average of Euro 96.29/MWh across 25 countries for 2017; the weighted average support ranged from a minimum of Euro 12.87/MWh in Norway to a maximum of Euro 198.29/MWh in the Czech Republic.
- Many CEER Member countries support renewable plants under different support systems – old plants still falling under a Feed-in-tariff system and new plants supported via more market-based systems like premiums. But: The CEER could not analyze the cost development for newly installed renewable capacities falling under the new support schemes (with in general lower support costs) because of lack of data.

Therefore, support for renewables is very likely to be lower nowadays because of decreasing prices.

**Table 7: Weighted average support level for RES in 2017, in Euro/MWh (CEER 2018)**

Country	Solar in Euro/MWh	Total RES in Euro/MWh
Austria	218.95	74.78
Croatia	189.05	55.86
Cyprus	208.00	174.74
Czech Republic	479.37	198.29
Denmark	94.97	44.69
Estonia	20.50	20.50
Finland	-	40.74
France	288.03	101.03
Germany	264.41	131.53
Greece	252.06	120.48
Hungary	52.78	58.03
Ireland	-	37.73
Italy	285.27	167.14
Latvia	-	117.44
Lithuania	326.48	56.42
Luxembourg	259.49	115.75
Malta	168.24	168.34
Netherlands	63.92	30.77
Norway	-	12.87
Poland	17.30	17.30
Portugal	247.92	50.59
Romania	45.08	45.08
Spain	279.89	84.46
Sweden	529.53	14.46
UK	51.76	51.76
Weighted average across 25 Members		96.29
Arithmetic average across 25 Members		79.63

The state support for PV in the Czech Republic is extraordinarily high compared to other countries. Especially PV has had problems in the Czech Republic from the beginning. The high support for PV starting in about 2006. It resulted in big PV projects (MW, brownfield), and the support level stayed too high for about five years and, moreover, was granted long-term. The high amounts of support did not cover for missing political support and good legal conditions. In 2010, even a special solar tax was introduced and owners of large PV plants had to pay back 26% on the revenues they generated. Since 2011, no big solar projects have therefore been implemented in the Czech Republic. What is annually growing is rooftop solar, with a capacity of 6 MW to date. In 2019, a bill has been drafted to introduce auctions for new renewable projects, but still not for solar parks. (Sedlák 2019)

Lower costs for PV will be reflected in decreasing state support as can be seen in the following figure for the USA. Unsubsidized costs for wind and solar with or without storage have already sunken below the costs of nuclear.

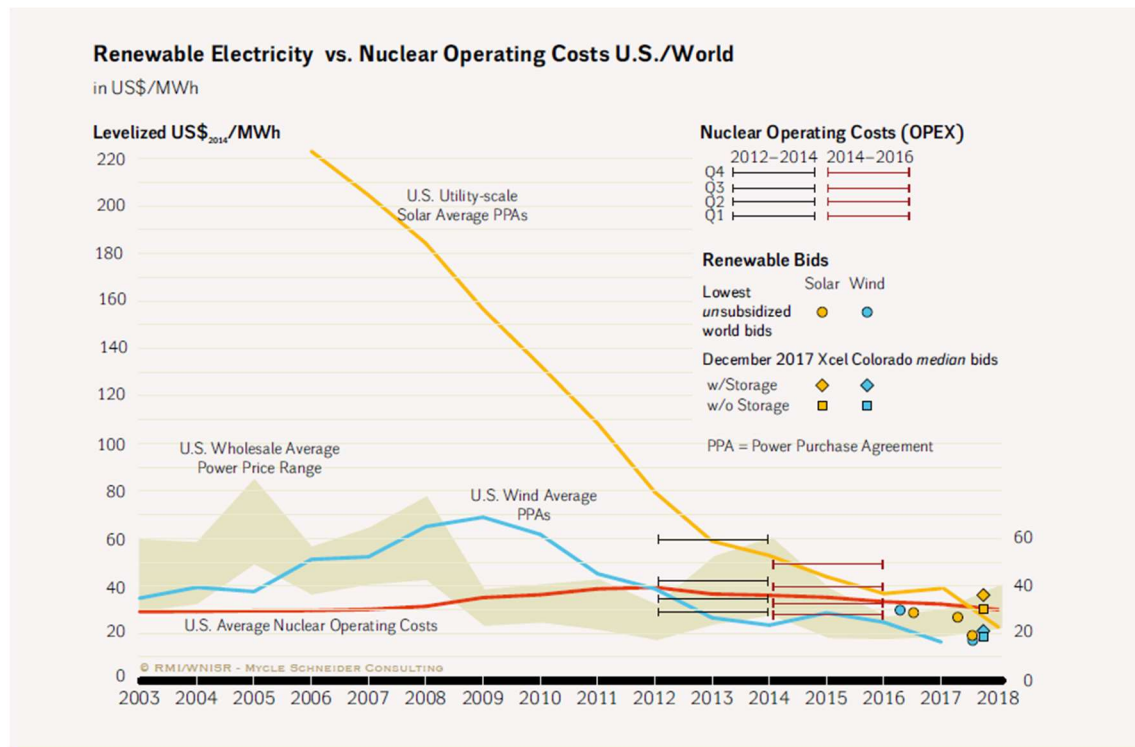

Sources: various compiled by Amory Lovins, Rocky Mountain Institute, 2019<sup>1026</sup>

Notes

Wind and Solar PPAs: US generation-weighted-average Power Purchase Agreements prices, by year of signing.

Nuclear operating cost: fuel, operation and maintenance, and Net Capital Additions average and quartiles. See Table 20 and Table 21.

Figure 13: Cost Evolution of New Renewables vs. Operating Nuclear in the USA (WNSIR 2019)

Besides subsidies in form of state aid (defined by the EU as “an advantage in any form whatsoever conferred on a selective basis to undertakings by national public authorities”<sup>4</sup>), support mechanisms like tax incentives, provisions for waste management or financing of research etc. also have to be compared to get the full picture. Those support costs cannot be seen in electricity prices. Nevertheless, the states and therefore the taxpayers have to pay those costs. A study for Germany (Wronski and Fiedler 2017) shows these hidden costs for the historical period 1970-2016. It becomes clear that coal and nuclear profited for decades of state aid and tax incentives.

<sup>4</sup> [https://ec.europa.eu/competition/state\\_aid/overview/index\\_en.html](https://ec.europa.eu/competition/state_aid/overview/index_en.html), seen 1 Oct ,2019

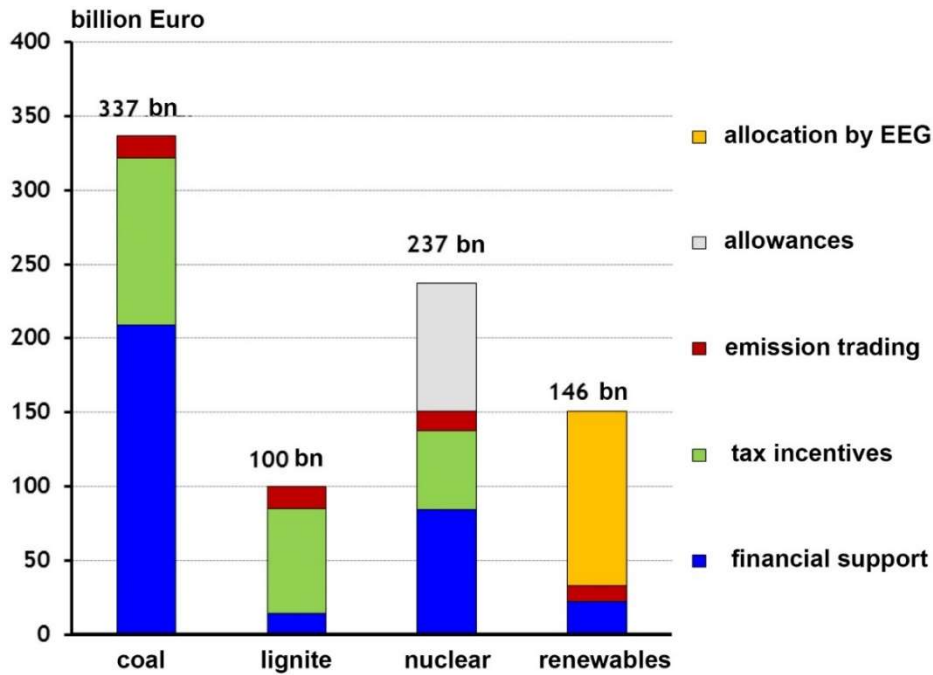

Figure 14: State support mechanisms 1970-2016 in Germany, in bn Euro (real) (Wronski and Fiedler 2017); EEG = Erneuerbare Energien Gesetz/Renewable Energy Law

Wronski and Fiedler (2017) also calculated the societal costs for electricity generation in 2016 by including external costs (figure 15). Nuclear energy in Germany received in its first years state support of more than 60 Ct/kWh. On the other hand, the relatively high costs for PV of 29.2 Ct/kWh are already decreasing due to decreasing remuneration costs.

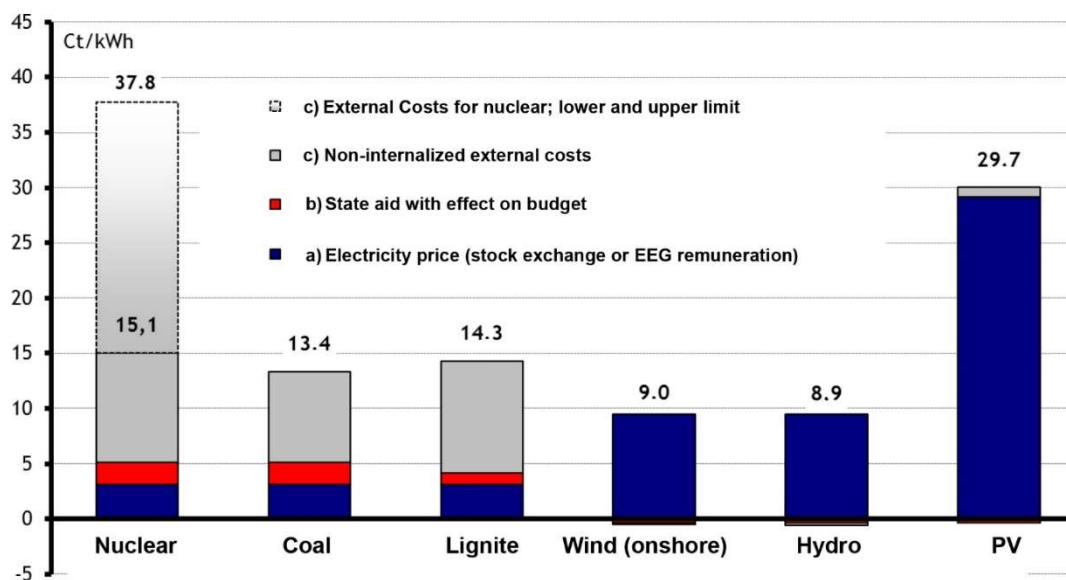
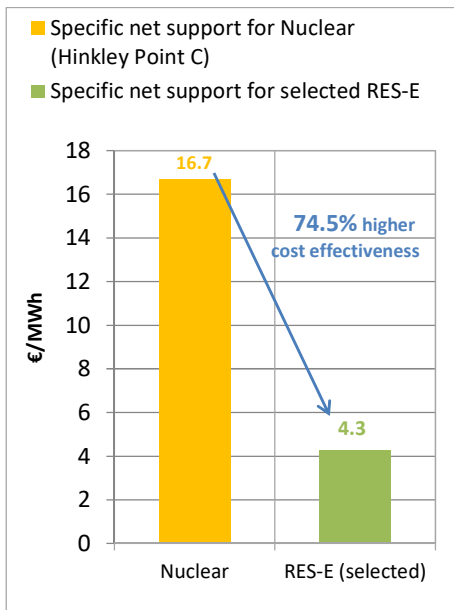
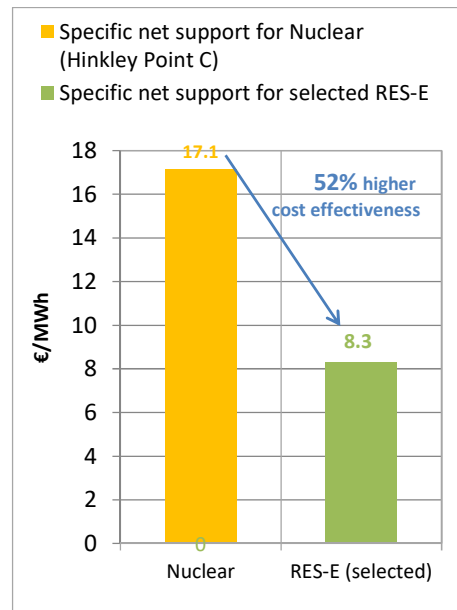

Figure 15: Societal costs for electricity production in Germany in 2016 in Ct/kWh; the external costs are based on data from 2012.

Imagine, that a new NPP will be built in an EU Member State which would get the same state aid as Hinkley Point C/UK – and imagine that the same amount of money would be used to build renewable energies instead: **What technologies are more cost effective?** In a study this question was assessed for the period 2023-2050 (Mraz et al. 2014). In a dynamic approach, a multitude of factors including costs, potentials, regulatory frameworks, diffusion constraints like non-cost barriers, electricity prices and energy demand were taken into account, all of which have a strong impact on the economics of power generation



**Figure 16: Comparison of overall cost-effectiveness: Specific net support for assessed RE technologies and nuclear power in Poland according to the Green-X scenario of dedicated RE support (Mraz et al. 2014)**



**Figure 17: Comparison of overall cost-effectiveness: Specific net support for assessed RE technologies and nuclear power in the Czech Republic according to the Green-X scenario of dedicated RE support (Mraz et al. 2014)**

Results for **Poland** show that supporting a basket of renewable energy technologies (biomass, onshore and offshore wind, small-scale hydropower plants and photovoltaics) shows a 74.5% higher cost-effectiveness than the planned support for Hinkley Point C. Poland possesses all opportunities to increase the deployment of renewables significantly in the mid- to long-term.

Results for the **Czech Republic** show a 52% higher cost-effectiveness than the planned support for a new nuclear power plant (similar to the aid scheme foreseen for Hinkley Point C). Thus, the Czech Republic has the potential to increase the deployment of renewables and this turns out to be significantly more cost effective than the nuclear alternative.

**Conclusions:**

It is not true that renewables today can only be realized because they are supported financially – on the contrary, renewables become cheaper every year while nuclear can only be realized if it is heavily supported by the state. The especially in the Czech Republic too high subsidies for PV were a mistake of the government and no argument for the discussion now (but a chance to learn).

Neither fossil nor nuclear energy can be built without support, but this support is partly not transparent.

Support schemes for renewables are different in every EU country. Data on new renewable plants which are supported under the new regulations are not available, therefore it cannot be analyzed easily yet if the changes introduced by the EU Renewable Energy Directive from 2009 already result in lower support. Nuclear energy, on the other hand, receives state support, too, like in Hinkley Point C, Paks II and possibly also in the upcoming financial scheme for Dukovany II.

The planned net support for Hinkley Point C/UK results is about 17 Euro/MWh – if these support costs would be invested in renewables, a 52% higher cost-effectiveness could be reached for the Czech Republic, and over 74% for Poland.

## 8 Energy supply security

Arguments from EIA procedures:

- Before Germany had announced its nuclear phase-out, transmission grids were stable. Now huge investments have to be made into the grid infrastructure.
- In Slovakia, no more licenses for photovoltaic plants have been issued because they are destabilizing the supply security system. Cross border transits from the West to the East and the South destabilize the technical infrastructure, too.
- A self-sustaining energy-island, on a regional or national level, is probably not functioning.

The question of energy supply security includes several topics, among others: Can supply meet demands or are there interruption in supply? How can so-called baseload plants work together with systems producing energy in changing amounts (renewable like PV and wind)? Are the European grids designed for it?

A high level of supply security cannot be guaranteed by a high share of fossil and nuclear capacity alone. In the following figure the SAIDI values for some EU countries with more or less renewables are compared (SAIDI = System Average Interruption Duration Index, in minutes). Countries with high share in nuclear mostly have higher SAIDI values.

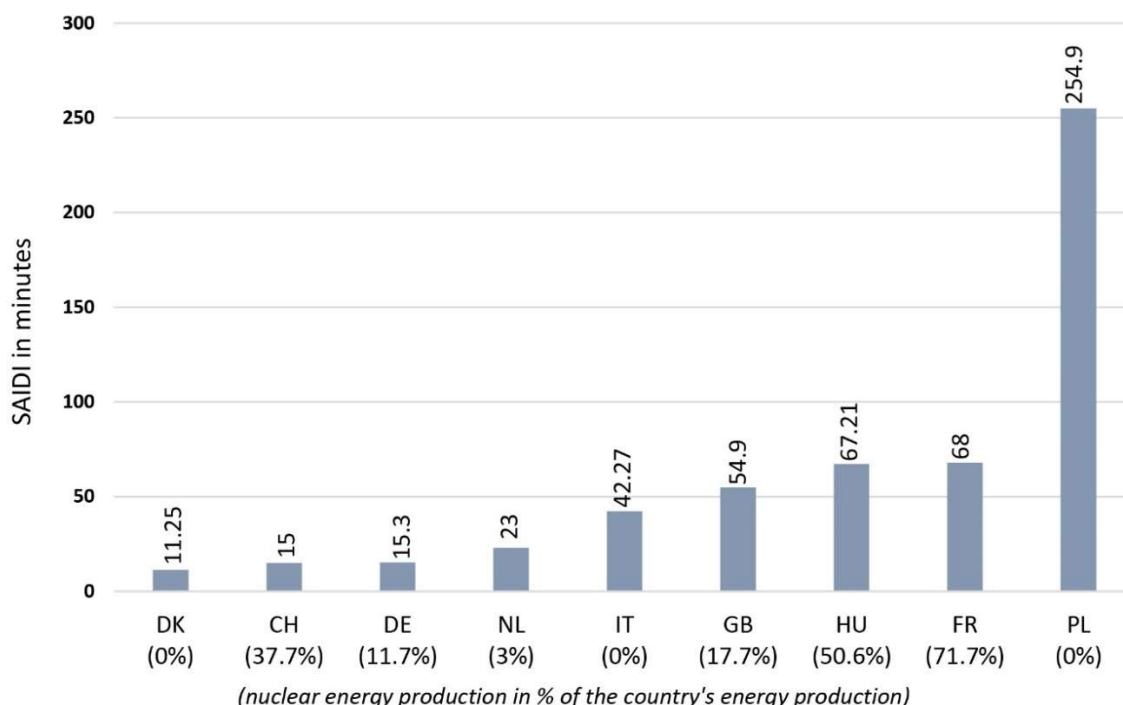

Figure 18: SAIDI values for 2013 (CEER 2015, cited after Energy Brainpool 2016) (in brackets share of nuclear energy on electricity production in %, IAEA PRIS)

Investments to stabilize cross border transmission have increased, but this is not a problem that is caused by Germany’s nuclear phase-out. The European network of transmission system operators for electricity (ENTSOE-E) has established the so-called ITC Fonds for compensation of transmission system operators for loss of energy due to transboundary transit and for costs due to infrastructure investment to enable cross border energy transit. Germany is since 2015 net contributor into this ITC Fonds. (Bundesnetzagentur and Bundeskartellamt 2018) Costs for grid adaption have to be paid but are shared on a European level.

Nuclear power plants are generally ascribed as highly available and predictable. But outages (planned or unplanned) lead to decreases in the steadiness of the supply level. For example, in France 2018 was the third year in a row that generation remained below 400 TWh; in 2005, nuclear generation peaked at 431.2 TWh. Every nuclear reactor in France was unavailable in average 87.6 days in 2018. France’s lifetime load factor remains constant below 70 percent (69.3 percent). The heat wave in the summer of 2019 led again to the closure or output reduction of several reactors, including the two Golfech units and the two Saint Alban units. (WNISR 2019)

An US operator, Pacific Gas and Electric Company, found that early closure of its well running Diablo Canyon NPP would save customers money and, by making the grid more flexible, raise renewables’ share. (WNISR 2019)

Controllable renewable power plants could be an alternative. Greenpeace Energy commissioned a study (Energy Brainpool 2018) to compare supply security by nuclear plants in the Visegrad countries to a model of controllable renewable power plants.

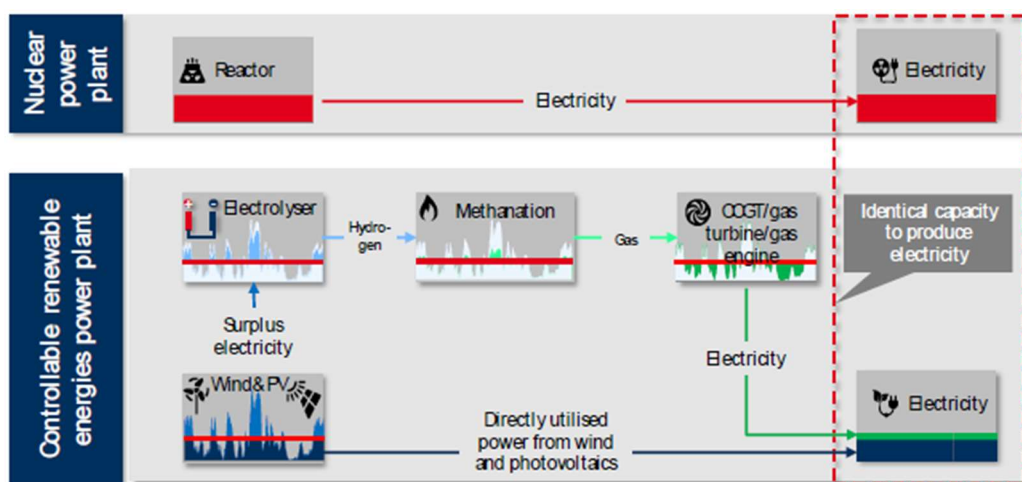

Figure 19: The concept of the controllable renewable energies power plant. (Energy Brainpool 2018)

Cost calculation for Czech Republic, Slovakia, Hungary and Poland resulted in total costs of 111-129 Euro/MWh for CZ, HU and PL, and for 167 Euro/MWh for Slovakia due to its low potential and limited experience with wind power. These costs were compared to expected costs for new nuclear plants of about 87-126 Euro/MWh (Hinkley Point C, Flamanville). Cost degredation of renewables could further reduce expected costs, while costs of nuclear can be expected to increase (see chapter 6).

The question if independent energy islands are a possible solution or not is dealt with in a new study (Child et al 2019) The authors compare two transition pathway towards a 100% renewable energy power sector by 2050: First, 20 European regions are acting as energy islands, and second, the same



regions are connected by a super grid. Which pathway has more potential to solve Europe's energy dilemma? Modelling considers current capacities and ages of power plants, as well as projected increases in future electricity demands. The authors conclude that a 100% RE energy system for Europe is economically competitive, technologically feasible, and consistent with targets of the Paris Agreement. The super grid pathway would result in even lower costs as the energy island pathway (in 2050 energy islands: 56 Euro/MWh, 51 Euro/MWh for the super grid). This suggests that there is merit in further development of a European Energy Union, one that provides clear governance at a European level, but allows for development that is appropriate for regional contexts.

**Conclusions:**

A comparison of system interruption duration shows that countries with a high nuclear power share mostly have higher interruption times. Analyses of the factual power output of NPP show that the outage times can be enormous, especially in old fleets like in France (average outage time of every reactor was 87.6 days in 2018).

On the other hand, growing renewable shares need new grid technologies and innovative flexibility and therefore investments. On a European level, mechanisms are being established to compensate for some of these costs.

New models are researched to re-think and reform the European energy system to allow for a share of up to 100% renewables in the next decades.

## 9 Annex: Information on installed capacities of renewable energies and produced electricity

The development of renewable energy technologies is fast and unstoppable.

IRENA presents data on installed capacity. From 2017 to 2018, 171 GW have been additionally installed **on a global level**. Total renewable energy generation capacity reached 2,351 GW at the end of last year – around a third of total installed electricity capacity.

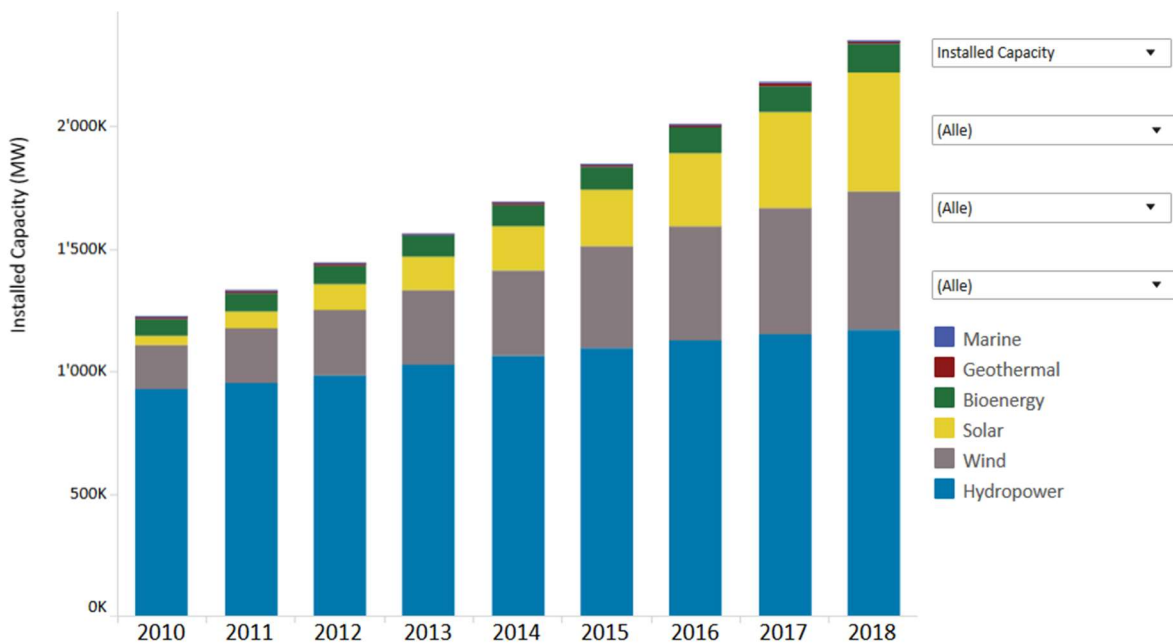

©IRENA Visit [www.irena.org/Statistics](http://www.irena.org/Statistics) for more information

Figure 20: Installed capacity for different renewables on a global level. IRENA website <https://www.irena.org/>, seen 01 Oct, 2019

The following figures show comparisons to nuclear energy. The nuclear share in electricity production is 10.15% in 2018. The small rise in 2018 is mainly due to Chinese NPP. As in previous years, in 2018, the “big five” nuclear generating countries—by rank, the U.S., France, China, Russia and South Korea—generated 70 percent of all nuclear electricity in the world.

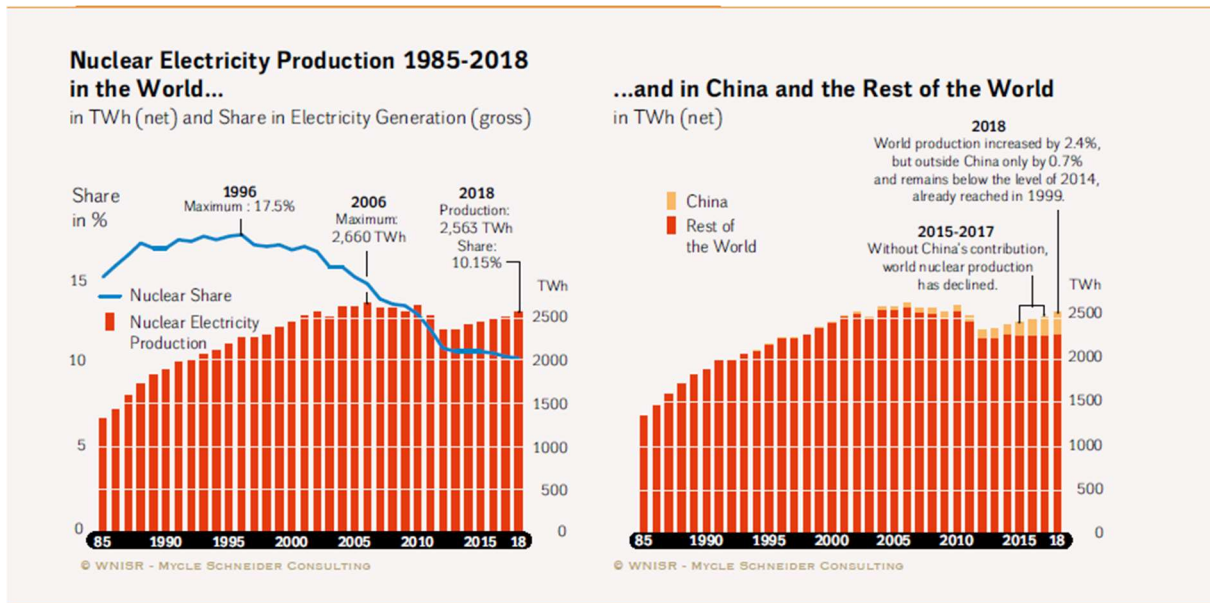

Sources: WNISR, with BP, IAEA-PRIS, 2019

Figure 21: Nuclear electricity production 1985-2018 (WNISR 2019)

On a European level:

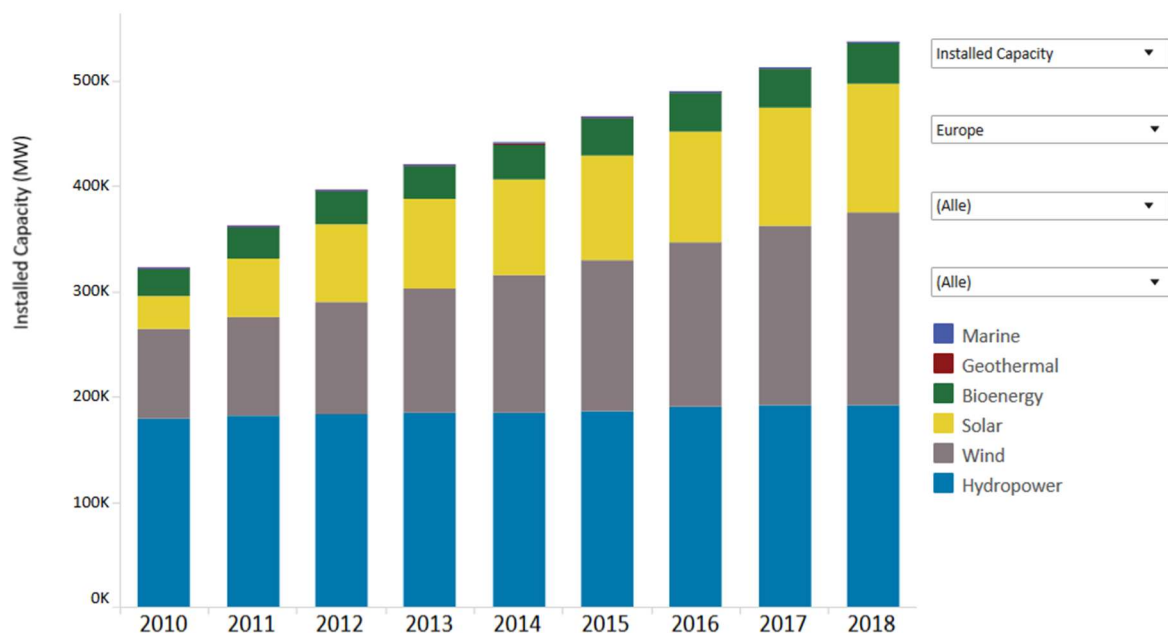

©IRENA Visit [www.irena.org/Statistics](http://www.irena.org/Statistics) for more information

Figure 22: Installed capacity for different renewables in Europe. IRENA website <https://www.irena.org/>, seen 01 Oct, 2019

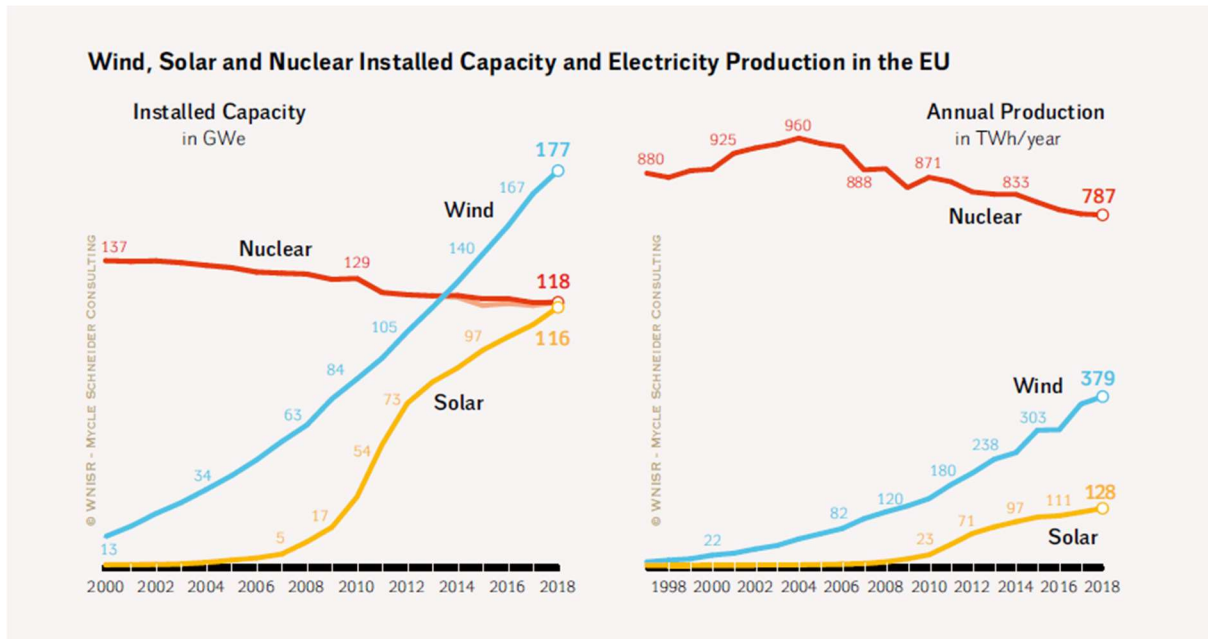

Figure 23: Wind, solar and nuclear capacity and electricity production in the EU 2000-2018 (WNISR 2019)

### Selected Member States

#### Poland:

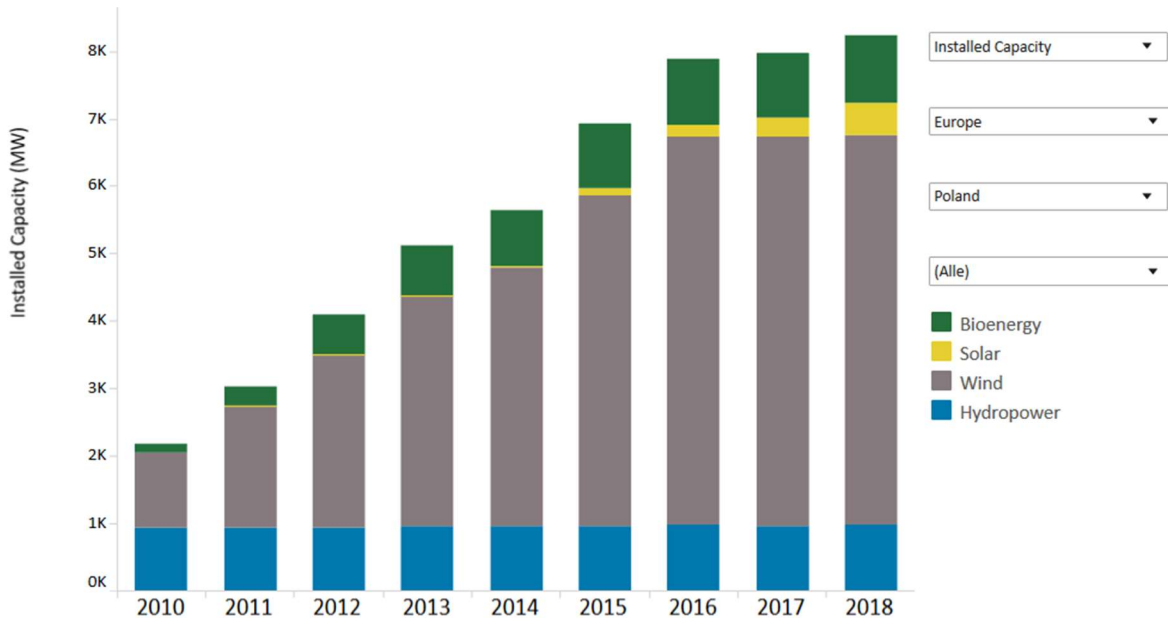

Figure 24: Installed capacity for different renewables for Poland. IRENA website <https://www.irena.org/>, seen 01 Oct, 2019

**Czech Republic:**

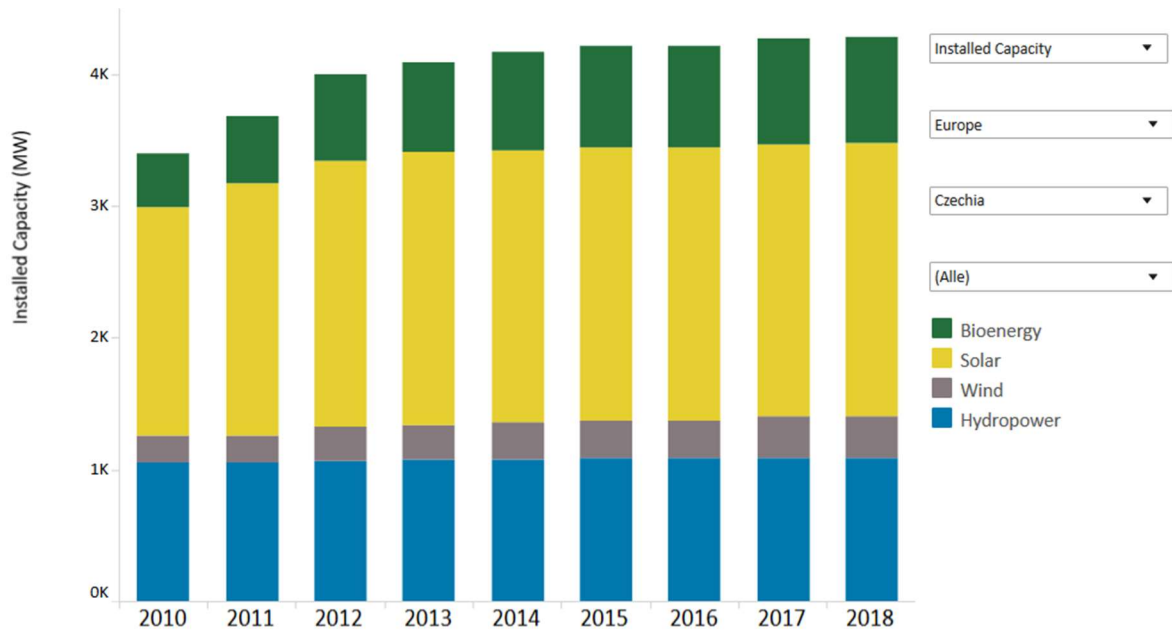

Figure 25: Installed capacity for different renewables for the Czech Republic. IRENA website <https://www.irena.org/>, seen 01 Oct, 2019

**Slovakia:**

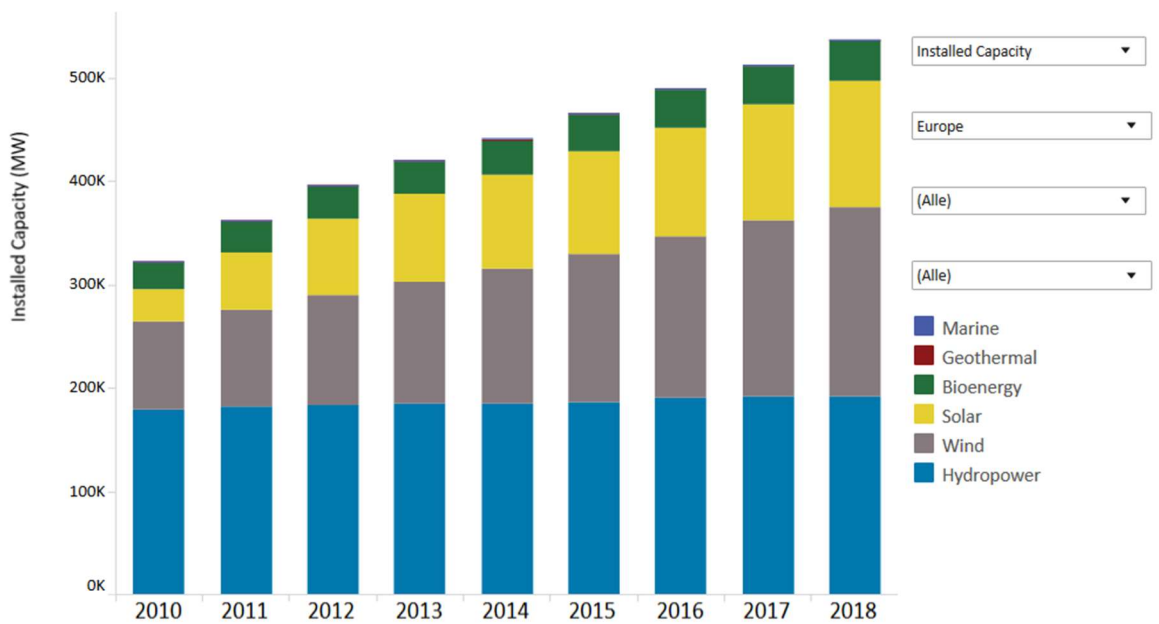

Figure 26: Installed capacity for different renewables for Slovakia. IRENA website <https://www.irena.org/>, seen 01 Oct, 2019

### Hungary:

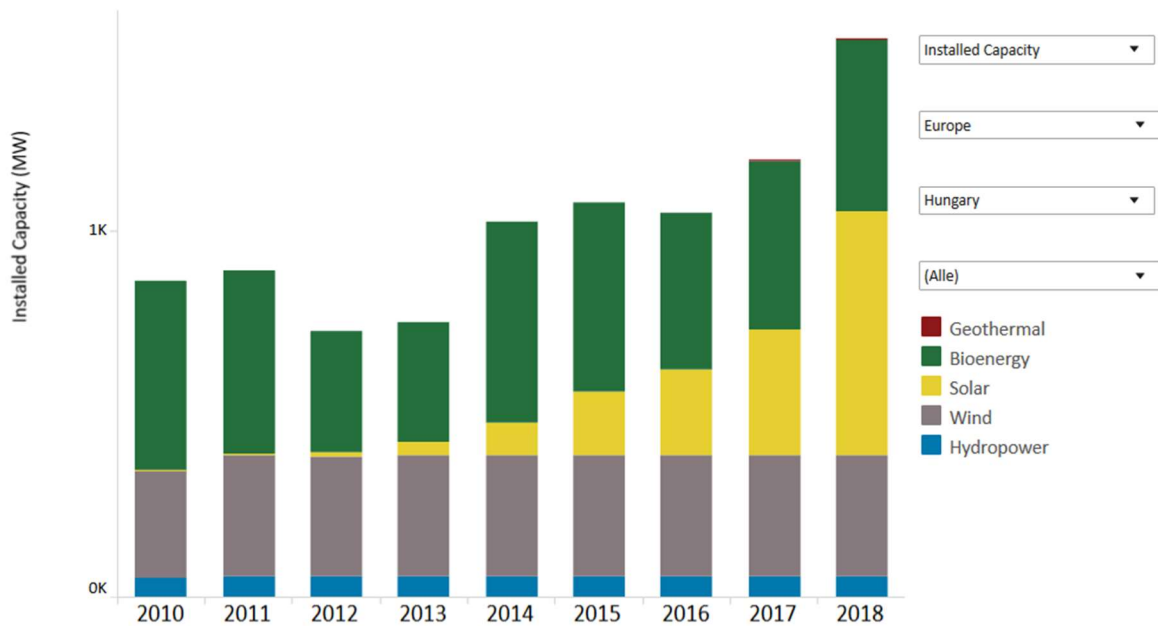

Figure 27: Installed capacity for different renewables for Hungary. IRENA website <https://www.irena.org/>, seen 01 Oct, 2019

### Bulgaria:

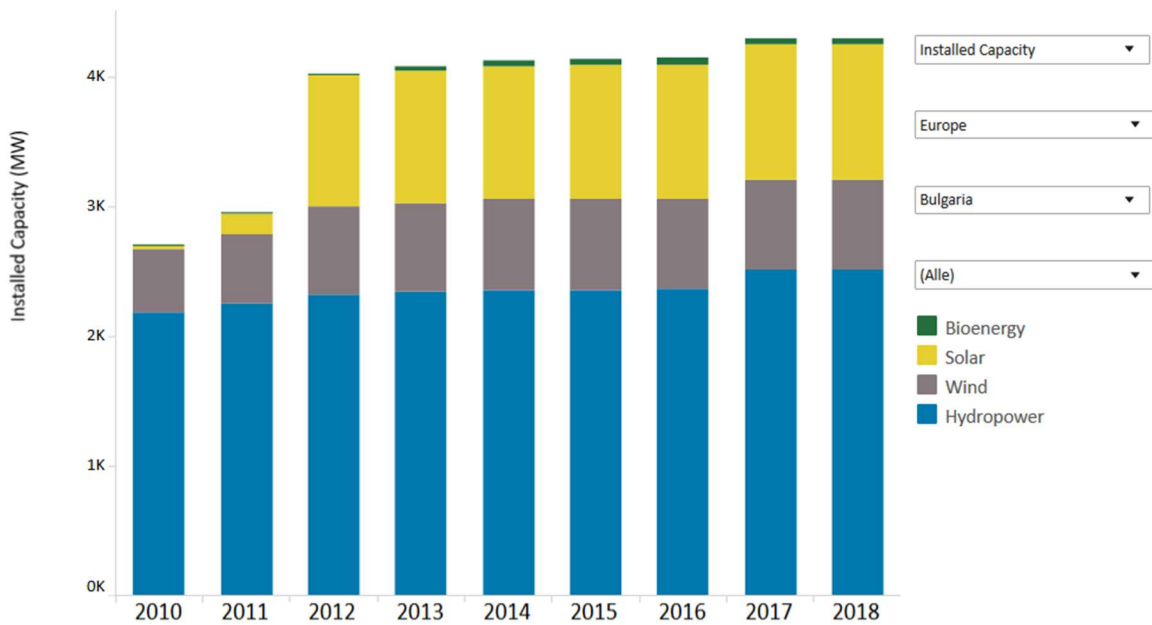

Figure 28: Installed capacity for different renewables for Bulgaria. IRENA website <https://www.irena.org/>, seen 01 Oct, 2019

## 10 References

- Bundesnetzagentur and Bundeskartellamt (2018): Monitoring Report 2018. Bonn.
- CEER – Council of European Energy Regulators (2018): Status Review of Renewable Support Schemes in Europe for 2016 and 2017. Public Report. Brussels, December 2018.
- Child, M., Kemfert, C., Bogdanov, D., Breyer, C. (2019): Flexible electricity generation, grid exchange and storage for the transition to a 100% renewable energy system in Europe. In: *Renewable Energy* 139 (2019), p. 80-101.
- CISL – University of Cambridge Institute for Sustainability Leadership (2019): The energy transition in Central and Eastern Europe: The business case for higher ambition. Cambridge, UK, The Prince of Wales's Corporate Leaders Group.
- Dominish, E., Briggs, C., Teske, S., Mey, F. (2019a): Chapter 10 - Just Transition: Employment Projections for the 2.0 °C and 1.5 °C Scenarios. In: Sven Teske (Ed.): *Achieving the Paris Climate Agreement Goals Global and Regional 100% Renewable Energy Scenarios with Non-energy GHG Pathways for +1.5°C and +2°C*.
- Dominish, E., Florin, N., Teske, S. (2019b): *Responsible Minerals Sourcing for Renewable Energy*. Report prepared for Earthworks by the Institute for Sustainable Futures, University of Technology Sydney.
- EC Report (2017): Report from the Commission to the Council and the European Parliament on progress of implementation of Council Directive 2011/70/Euratom and an inventory of radioactive waste and spent fuel present in the Community's territory and the future prospects. Brussels, 15.5.2017, COM(2017) 236 final.
- Energieatlas (2018): *Daten und Fakten über die Erneuerbaren in Europa*. Hg. Von Heinrich Böll Stiftung, Green European Foundation, European Renewable Energies Federation, Le Monde diplomatique. Berlin.
- Energy Brainpool (2016): *The Consequences so far of Germany's Nuclear Phaseout on the Security of Energy Supply*. A brief analysis commissioned by Greenpeace Energy eG in Germany.
- Energy Brainpool (2018): *Controllable Renewable Energies: An Alternative to Nuclear Power. Cost Comparisons for Poland, Slovakia, Czech Republic and Hungary*. A short study for Greenpeace Energy eG. Authors: Fabian Huneke and Philipp Heidinger. Berlin.
- Eurostat (2019): Electricity Price statistics May 2019. [https://ec.europa.eu/eurostat/statistics-explained/index.php?title=Electricity\\_price\\_statistics](https://ec.europa.eu/eurostat/statistics-explained/index.php?title=Electricity_price_statistics), seen 28 Sept., 2019.
- Frantál, B., Malý, J., Ouředníček, M., Nemeškal, J. (2016): Distance matters. Assessing socioeconomic impacts of the Dukovany nuclear power plant in the Czech Republic: Local perceptions and statistical evidence. *Moravian Geographical Reports*, 24(1): 2–13. Doi: 10.1515/mgr-2016-0001.
- Fraunhofer ISE (Institut für Solare Energiesysteme) (2018): *Photovoltaics Report*. Prepared by Fraunhofer Institute for Solar Energy Systems, ISE with support of PSE Conferences & Consulting GmbH Freiburg, 26 February 2018 [www.ise.fraunhofer.de](http://www.ise.fraunhofer.de)
- Gabriel, Sigmar (2016): Talk at the international conference "Berlin Energy Transition Dialogue", 17-18 March 2016. <https://www.greenpeace-energy.de/blog/wissen/energiepolitik/gabriel-atomkraft-ist-teuer-und-schafft-weniger-arbeitsplaetze-als-erneuerbare/>, seen 18 Nov 2019.
- Giurco, D., Dominish, E., Florin, N., Watari, T., McLellan, B. (2019): Requirements for Minerals and metals for 100% Renewable Scenarios. In: Teske et al. (2019): p. 437-457
- Günther, B., Karau, T., Kastner, E.M., Warmuth, W. (2011): *Versicherungsforen Leipzig: Berechnung einer risikoadäquaten Versicherungsprämie zur Deckung der Haftpflichtrisiken, die aus dem Betrieb von Kernkraftwerken resultieren*. Eine Studie im Auftrag des Bundesverband Erneuerbare Energie e.V. (BEE). Leipzig.
- Haas, R., Thomas, S., Ajanovic, A. (2019): The Historical Development of the Costs of Nuclear Power. In: Haas, R., Mez, L., Ajanovic, A. (Ed.): *The Technological and Economic Future of Nuclear Power*. Springer, p. 97-115.
- IPCC (2011): *Summary for Policymakers*. In: IPCC Special Report on Renewable Energy Sources and Climate Change Mitigation. [O. Edenhofer, R. Pichs-Madruga, Y. Sokona, K. Seyboth, P. Matschoss, S. Kadner, T. Zwickel, P. Eickemeier, G. Hansen, S. Schlömer, C. von Stechow (eds)], Cambridge University Press, Cambridge, United Kingdom and New York, NY, USA.
- IPCC (2012): *Renewable Energy Sources and Climate Change Mitigation*. Special Report of the Intergovernmental Panel on Climate Change. [O. Edenhofer, R. Pichs-Madruga, Y. Sokona, K. Seyboth, P. Matschoss, S. Kadner, T. Zwickel, P. Eickemeier, G. Hansen, S. Schlömer, C. von Stechow (eds)], Cambridge University Press, Cambridge, United Kingdom and New York, NY, USA.
- IPCC (2014): *Climate Change 2014: Mitigation of Climate Change*. Contribution of Working Group III to the Fifth Assessment Report of the Intergovernmental Panel on Climate Change [Edenhofer, O., R. Pichs-Madruga, Y. Sokona, E. Farahani, S. Kadner,

K., Seyboth, A. Adler, I. Baum, S. Brunner, P. Eickemeier, B. Kriemann, J. Savolainen, S. Schlömer, C. von Stechow, T. Zwickel and J.C. Minx (eds.)). Cambridge University Press, Cambridge, United Kingdom and New York, NY, USA.

IRENA (2019): Renewable Power Generation Costs in 2018. International Renewable Energy Agency, Abu Dhabi.

IRENA and IEA-PVPS (2016): End-of-life Management. Solar Photovoltaic panels.

IRSN (2012): Pascucci-Cahen, L.; Momal, P.: Massive radiological releases profoundly differ from controlled releases. Presented at Eurosafe-Forum Nov. 2012. Fontenay-aux-Roses.

Moss, R.L., Tzimas, E., Kara, H., Willis, P., Kooroshy, J. (2011): Critical Metals in Strategic energy Technologies. Assessing Rare Metals as Supply-Chain Bottlenecks in Low-Carbon Energy Technologies. Joint Research Center.

Moss, R.L., Tzimas, E., Willis, P., Arendorf, J., Tercero Espinoza, L. et al. (2013): Critical Metals in the Path towards the Decarbonisation of the EU Energy Sector. Assessing Rare Metals as Supply-Chain Bottlenecks in Low-Carbon Energy Technologies. Joint Research Center.

Mraz, G., Lorenz, P. (2019): Nuclear waste management in the EU: Implementation of Directive 2011/70/EURATOM. Joint Project Assessment Report. Version v3 of June 2019.

Mraz, G., Wallner, A., Resch, G., Suna, D. (2014): Renewable Energies versus Nuclear Power. Comparing Financial Support. Study commissioned by Wiener Umweltschutz / Vienna Ombuds-Office for Environmental Protection. Vienna.

NEA-OECD (2010): Comparing Nuclear Accident Risks with Those from Other Energy Sources. NEA No. 6861.

Ram M., Bogdanov D., Aghahosseini A., Gulagi A., Oyewo A.S., Child M., Caldera U., Sadovskaia K., Farfan J., Barbosa LSNS., Fasihi M., Khalili S., Fell H.-J., Breyer C. (2018): Global Energy System based on 100% Renewable Energy – Energy Transition in Europe Across Power, Heat, Transport and Desalination Sectors. Study by LUT University and Energy Watch Group, Lappeenranta, Berlin.

Sedláč, M. (2019): The age of Czech solar power: after years of stagnation, is a rebirth imminent? 20 March 2019. <https://energytransition.org/2019/03/czech-solar-power-after-years-of-stagnation/>, seen 3 Oct 2019

Sovacool, B. (2008): Valuing the greenhouse gas emissions from nuclear power: A critical survey. In: Energy Policy 36 (2008), p. 2940–2953.

Teske, S., Dominish, E., Briggs, C., Mey, F., Rutovitz, J. (2019): Outlook on employment effects of a Global Energy Transition. Prepared for Greenpeace Foundation, Germany.

Tokimatsu, K., Höök, M., McLellan, B., Wachtmeister, H., Murakami, S., Yasuoka, R., Nishio, M. (2018): Energy modeling approach to the global energy-mineral nexus: Exploring metal requirements and the well-below 2 °C target with 100 percent renewable energy. In: Applied Energy 225, p. 1158-1175.

Uranatlas (2019): Daten und Fakten über den Rohstoff des Atomzeitalters. Hg. von Le Monde diplomatique, Nuclear Free Future Foundation, Rosa-Luxemburg-Stiftung, BUND.

Wallner, A. (2012): Uranium Mining in and for Europe. On behalf of the Wiener Umweltschutz.

Wallner, A., Mraz, G. (2013): The true costs of nuclear power. Study commissioned by Wiener Umweltschutz /Vienna Environmental Ombudsman. Vienna.

Wallner, A., Wenisch, A., Baumann, M., Renner, S. (2011): Energy balance of nuclear power generation. Life cycle analysis of nuclear power: Energy balance and CO<sub>2</sub> emissions. Based on a project funded in New Energies 2020, funded by WUA.

Weiß, J., Prah, A., Neumann, A., Schröder, A., Bettgenhäuser, K., Hermelink, A., John, A., v. Manteuffel, B. (2014): Kommunale Wertschöpfungseffekte durch energetische Gebäudesanierung (KoWeG): IÖW, ECOFYS. Im Auftrag des Bundesministeriums für Umwelt, Naturschutz, Bau und Reaktorsicherheit. Endbericht. Berlin.

Wheatley, S., Sovacool, B.K., Sornette, D. (2016): Reassessing the safety of nuclear power. In: Energy Research & Social Science 15: p. 96–100.

WNSIR (2019): World Nuclear Industry Status Report. Schneider, M.; Frogatt, A. et al.. Paris, Budapest, September 2019.

World Bank (2017): The Growing Role of Minerals and Metals for a low Carbon Future. Washington, DC.

Wronski, R., Fiedler, S. (2017): Was Strom wirklich kostet. Vergleich der staatlichen Förderungen und gesamtgesellschaftlichen Kosten von konventionellen und erneuerbaren Energien. Überarbeitet und aktualisierte Auflage Okt. 2017. Forum ökologisch-soziale Marktwirtschaft. Im Auftrag von Greenpeace Energy.



## 11 Abbreviations

CO <sub>2</sub> eq	CO <sub>2</sub> equivalent
EIA	Environmental Impact Assessment
EU	European Union
GW electric year (GWey)	GigaWatt (electric) year: the energy that is produced by a power plant with 1 GW(electric power) in one year
IPCC	Intergovernmental Panel on Climate Change
IRENA	International Renewable Energy Agency
LCOE	Levelized Cost of Electricity
MW	MegaWatt
NEA	Nuclear Energy Agency
NPP	Nuclear Power Plant
OECD	Organisation for Economic Co-operation and Development
PV	Photovoltaics
PWE	Pressurized Water Reactor
RE, RES	Renewable Energies, Renewable Energy Systems
REE	Rare Earth Elements
USC	US Dollar

## 12 List of Figures and Tables

FIGURE 1: DIFFERENT CATEGORIES OF JOBS CREATED IN A SCENARIO OF UP TO 100% RENEWABLES UP TO 2050 (RAM ET AL. 2018, P. 20) .....	8
FIGURE 2: JOBS CREATED BY VARIOUS POWER GENERATION AND STORAGE TECHNOLOGIE, SCENARIO UP TO 2050 IN EUROPE (RAM ET AL. 2018, P. 20) .....	8
FIGURE 3: COMPARISON OF FATALITY RATES AND MAXIMUM CONSEQUENCES OF OPERATING LARGE ENERGY TECHNOLOGIES, INCLUDING ACCIDENTS IN THE FUEL CHAIN; THE ACCIDENT OF FUKUSHIMA IS NOT INCLUDED. (IPCC 2012, P. 746) .....	12
FIGURE 4: EVOLUTION TO 2030 OF MATERIALS USED FOR DIFFERENT PV PANEL TECHNOLOGIES AS A PERCENTAGE OF TOTAL PANEL MASS (IRENA AND IEA-PVPS 2016, P. 41) .....	15
FIGURE 5: END-OF-LIFE RECOVERY POTENTIAL UNDER REGULAR-LOSS SCENARIO TO 2030, IN TONS (IRENA AND IEA-PVPS 2016) .....	16
FIGURE 6: ESTIMATES OF LIFECYCLE GREENHOUSE GAS EMISSION IN CO <sub>2</sub> EQ/KWH (IPCC 2011, P. 19) .....	17
FIGURE 7: CO <sub>2</sub> EMISSIONS FROM VARIOUS ENERGY PRODUCTION SYSTEMS, IN G CO <sub>2</sub> PER KWH. (URANATLAS 2019) .....	18
FIGURE 8: LIFE-CYCLE INVENTORY RESULTS OF THE PRODUCTION OF 1 KWH OF ELECTRICITY. (VARIOUS DATA SOURCES, QUOTED IN IPCC 2014, P. 548) .....	19
FIGURE 9: A COMPARISON OF STUDIES ON THE HISTORICAL DEVELOPMENT OF INVESTMENT COSTS OF NPPs (HAAS ET AL. 2019) .....	21
FIGURE 10: INCREASE IN CONSTRUCTION TIMES ON NUCLEAR NEW BUILD PROJECTS (HAAS ET AL. 2019) .....	21
FIGURE 11: THE DECLINING COST OF RENEWABLES VERSUS TRADITIONAL POWER SOURCES (WNISR 2019, FIG 40, BASED ON LAZARD 2018) (1 USD/MWH IN 2018 EQUALS 0.85 EURO/MWH) .....	22
FIGURE 12: FRAUNHOFER ISE (2018): ENERGY PAYBACK TIMES OF MULTICRYSTALLINE SILICONE PV ROOFTOP SYSTEMS – GEOGRAPHICAL COMPARISON .....	23
FIGURE 13: COST EVOLUTION OF NEW RENEWABLES VS. OPERATING NUCLEAR IN THE USA (WNSIR 2019).....	27
FIGURE 14: STATE SUPPORT MECHANISMS 1970-2016 IN GERMANY, IN BN EURO (REAL) (WRONSKI AND FIEDLER 2017); EEG = ERNEUERBARE ENERGIEN GESETZ/RENEWABLE ENERGY LAW .....	28
FIGURE 15: SOCIETAL COSTS FOR ELECTRICITY PRODUCTION IN GERMANY IN 2016 IN CT/KWH; THE EXTERNAL COSTS ARE BASED ON DATA FROM 2012. ....	28
FIGURE 16: COMPARISON OF OVERALL COST-EFFECTIVENESS: SPECIFIC NET SUPPORT FOR ASSESSED RE TECHNOLOGIES AND NUCLEAR POWER IN POLAND ACCORDING TO THE GREEN-X SCENARIO OF DEDICATED RE SUPPORT (MRAZ ET AL. 2014) .....	29
FIGURE 17: COMPARISON OF OVERALL COST-EFFECTIVENESS: SPECIFIC NET SUPPORT FOR ASSESSED RE TECHNOLOGIES AND NUCLEAR POWER IN THE CZECH REPUBLIC ACCORDING TO THE GREEN-X SCENARIO OF DEDICATED RE SUPPORT (MRAZ ET AL. 2014).....	29
FIGURE 18: SAIDI VALUES FOR 2013 (CEER 2015, CITED AFTER ENERGY BRAINPOOL 2016) (IN BRACKETS SHARE OF NUCLEAR ENERGY ON ELECTRICITY PRODUCTION IN %, IAEA PRIS) .....	31
FIGURE 19: THE CONCEPT OF THE CONTROLLABLE RENEWABLE ENERGIES POWER PLANT. (ENERGY BRAINPOOL 2018).....	32
FIGURE 20: INSTALLED CAPACITY FOR DIFFERENT RENEWABLES ON A GLOBAL LEVEL. IRENA WEBSITE <a href="https://www.irena.org/">HTTPS://WWW.IRENA.ORG/</a> , SEEN 01 OCT, 2019 .....	34
FIGURE 21: NUCLEAR ELECTRICITY PRODUCTION 1985-2018 (WNISR 2019) .....	35
FIGURE 22: INSTALLED CAPACITY FOR DIFFERENT RENEWABLES IN EUROPE. IRENA WEBSITE <a href="https://www.irena.org/">HTTPS://WWW.IRENA.ORG/</a> , SEEN 01 OCT, 2019 .....	35
FIGURE 23: WIND, SOLAR AND NUCLEAR CAPACITY AND ELECTRICITY PRODUCTION IN THE EU 2000-2018 (WNISR 2019) .....	36
FIGURE 24: INSTALLED CAPACITY FOR DIFFERENT RENEWABLES FOR POLAND. IRENA WEBSITE <a href="https://www.irena.org/">HTTPS://WWW.IRENA.ORG/</a> , SEEN 01 OCT, 2019 .....	36

FIGURE 25: INSTALLED CAPACITY FOR DIFFERENT RENEWABLES FOR THE CZECH REPUBLIC. IRENA WEBSITE HTTPS://WWW.IRENA.ORG/, SEEN 01 OCT, 2019 .....	37
FIGURE 26: INSTALLED CAPACITY FOR DIFFERENT RENEWABLES FOR SLOVAKIA. IRENA WEBSITE HTTPS://WWW.IRENA.ORG/, SEEN 01 OCT, 2019 .....	37
FIGURE 27: INSTALLED CAPACITY FOR DIFFERENT RENEWABLES FOR HUNGARY. IRENA WEBSITE HTTPS://WWW.IRENA.ORG/, SEEN 01 OCT, 2019 .....	38
FIGURE 28: INSTALLED CAPACITY FOR DIFFERENT RENEWABLES FOR BULGARIA. IRENA WEBSITE HTTPS://WWW.IRENA.ORG/, SEEN 01 OCT, 2019 .....	38
TABLE 1: GLOBAL TOTAL EMPLOYMENT (THOUSAND JOBS) IN A 5.0°C AND 1.5°C SCENARIO (TESKE ET AL. 2019, P. 23) .....	6
TABLE 2: JOB YEARS AND JOBS PER MW IN 2012 (DOMINISH ET AL. 2019A) .....	7
TABLE 3: SEVERE ACCIDENTS (DEFINED AS >= 5 FATALITIES) IN FOSSIL, HYDRO AND NUCLEAR ENERGY PRODUCTION CHAINS DURING 1969-2000. FATALITIES FOR NUCLEAR ARE IMMEDIATE FATALITIES ONLY. NEA-OECD (2010, P. 35) .....	11
TABLE 4: COMPARISON OF METAL USE OF NUCLEAR, PV AND WIND (WORLD BANK GROUP 2017; DOMINISH ET AL. 2019B; DATA ON NUCLEAR FROM MOSS ET AL. 2011; TOKIMATSU ET AL. 2018) .....	14
TABLE 5: CRITICALITY RATING OF SHORTLISTED RAW MATERIALS (MOSS ET AL. 2013), REE = RARE EARTH ELEMENTS	15
TABLE 6: GLOBAL ELECTRICITY COSTS IN 2018, CHANGE IN COST 2017-2018 (IRENA 2019) (1 USD/KWH IN 2018 EQUALS 0.85 EURO/KWH) .....	22
TABLE 7: WEIGHTED AVERAGE SUPPORT LEVEL FOR RES IN 2017, IN EURO/MWH (CEER 2018) .....	26